

SHARP SERVICE MANUAL

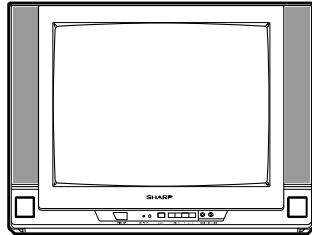

COLOR TELEVISION

Chassis No. MSA

MODELS **20SL43**

In the interests of user-safety (Required by safety regulations in some countries) the set should be restored to its original condition and only parts identical to those specified should be used.

CONTENTS

	Page
• ELECTRICAL SPECIFICATIONS	1
• IMPORTANT SERVICE SAFETY PRECAUTION	2
• LOCATION OF USER'S CONTROL	4
• INSTALLATION AND SERVICE INSTRUCTIONS	5
• CHASSIS LAYOUT	13
• BLOCK DIAGRAM	14
• SCHEMATIC DIAGRAMS	18
• PRINTED WIRING BOARD ASSEMBLIES	21
• REPLACEMENT PARTS LIST	24
• PACKING OF THE SET	29

ELECTRICAL SPECIFICATIONS

POWER INPUT 110-220 V AC 50/60 Hz
 POWER RATING 72 W
 PICTURE SIZE 1,194 cm² (185sq inch)
 CONVERGENCE Magnetic
 SWEEP DEFLECTION Magnetic
 FOCUS QPF Electrostatic
 INTERMEDIATE FREQUENCIES
 Picture IF Carrier Frequency 45.75 MHz
 Sound IF Carrier Frequency 41.25 MHz
 Color Sub-Carrier Frequency 42.17 MHz
 (Nominal)
 AUDIO POWER
 OUTPUT RATING 1.5 + 1.5 W (at 10% distortion)

SPEAKER
 SIZE 9 × 5 cm (Round)
 VOICE COIL IMPEDANCE 32 ohm at 400 Hz
 ANTENNA INPUT IMPEDANCE
 VHF/UHF 75 ohm Unbalanced
 TUNING RANGES
 VHF-Channels 2 thru 13
 UHF-Channels 14 thru 69
 CATV Channels 1 thru 125

Specifications are subject to change without prior notice.

IMPORTANT SERVICE SAFETY PRECAUTION

- Service work should be performed only by qualified service technicians who are thoroughly familiar with all safety checks and the servicing guidelines which follow:

WARNING

1. For continued safety, no modification of any circuit should be attempted.
2. Disconnect AC power before servicing.
3. Semiconductor heat sinks are potential shock hazards when the chassis is operating.
4. The chassis in this receiver has two ground systems which are separated by insulating material. The non-isolated (hot) ground system is for the B+ voltage regulator circuit and the horizontal output circuit. The isolated ground system is for the low B+ DC voltages and the secondary circuit of the high voltage transformer.
To prevent electrical shock use an isolation transformer between the line cord and power receptacle, when servicing this chassis.

SERVICING OF HIGH VOLTAGE SYSTEM AND PICTURE TUBE

When servicing the high voltage system, remove the static charge by connecting a 10k ohm resistor in series with an insulated wire (such as a test probe) between the picture tube ground and the anode lead. (AC line cord should be disconnected from AC outlet.)

1. Picture tube in this receiver employs integral implosion protection.
2. Replace with tube of the same type number for continued safety.
3. Do not lift picture tube by the neck.
4. Handle the picture tube only when wearing shatterproof goggles and after discharging the high voltage anode completely.

X-RADIATION AND HIGH VOLTAGE LIMITS

1. Be sure all service personnel are aware of the procedures and instructions covering X-radiation. The only potential source of X-ray in current solid state TV receivers is the picture tube. However, the picture tube does not emit measurable X-Ray radiation, if the high voltage is as specified in the "High Voltage Check" instructions.
It is only when high voltage is excessive that X-radiation is capable of penetrating the shell of the picture tube including the lead in the glass material. The important precaution is to keep the high voltage below the maximum level specified.
2. It is essential that servicemen have available at all times an accurate high voltage meter. The calibration of this meter should be checked periodically.
3. High voltage should always be kept at the rated value –no higher. Operation at higher voltages may cause a failure of the picture tube or high voltage circuitry and;also, under certain conditions, may produce radiation in exceeding of desirable levels.
4. When the high voltage regulator is operating properly there is no possibility of an X-radiation problem. Every time a color chassis is serviced, the brightness should be tested while monitoring the high voltage with a meter to be certain that the high voltage does not exceed the specified value and that it is regulating correctly.
5. Do not use a picture tube other than that specified or make unrecommended circuit modifications to the high voltage circuitry.
6. When trouble shooting and taking test measurements on a receiver with excessive high voltage, avoid being unnecessarily close to the receiver.
Do not operate the receiver longer than is necessary to locate the cause of excessive voltage.

IMPORTANT SERVICE SAFETY PRECAUTION

(Continued)

BEFORE RETURNING THE RECEIVER

(Fire & Shock Hazard)

Before returning the receiver to the user, perform the following safety checks.

1. Inspect all lead dress to make certain that leads are not pinched or that hardware is not lodged between the chassis and other metal parts in the receiver.
2. Inspect all protective devices such as non-metallic control knobs, insulating materials, cabinet backs, adjustment and compartment covers or shields, isolation resistor-capacity networks, mechanical insulators and etc.
3. To be sure that no shock hazard exists, check for leakage current in the following manner.
 - Plug the AC cord directly into a 110~220 volt AC outlet, (Do not use an isolation transformer for this test).
 - Using two clip leads, connect a 1.5k ohm, 10 watt resistor paralleled by a 0.15 μ F capacitor in series with all exposed metal cabinet parts and a known earth ground, such as electrical conduit or electrical ground connected to earth ground.
 - Use an AC voltmeter having with 5000 ohm per volt, or higher, sensitivity to measure the AC voltage drop across the resistor.

- Connect the resistor connection to all exposed metal parts having a return to the chassis (antenna, metal cabinet, screw heads, knobs and control shafts, escutcheon and etc.) and measure the AC voltage drop across the resistor.

All checks must be repeated with the AC ine cord plug connection reversed. (If necessary, a non-polarized adapter plug must be used only for the purpose of completing these check.)

Any current measured must not exceed 0.5 milliamp. Any measurements not within the limits outlined above indicate of a potential shock hazard and corrective action must be taken before returning the instrument to the customer.

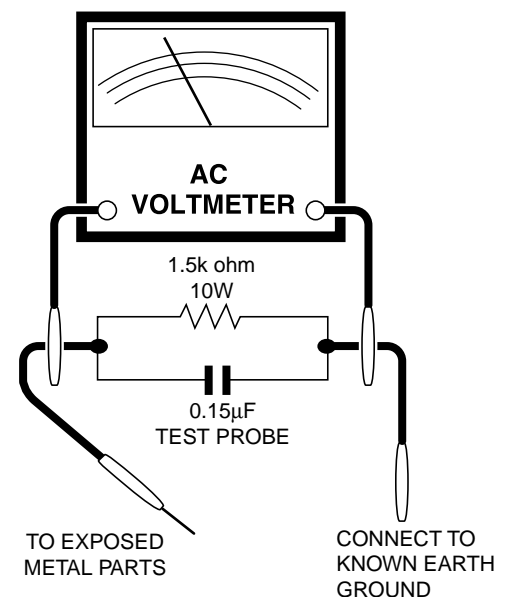

SAFETY NOTICE

Many electrical and mechanical parts in television receivers have special safety-related characteristics. These characteristics are often not evident from visual inspection, nor can protection afforded by them be necessarily increased by using replacement components rated for higher voltage, wattage, etc.

Replacement parts which have these special safety characteristics are identified in this manual; electrical components having such features are identified by " \triangle " and shaded areas in the Replacement Parts Lists and Schematic Diagrams.

For continued protection, replacement parts must be identical to those used in the original circuit. The use of substitute replacement parts which do not have the same safety characteristics as the factory recommended replacement parts shown in this service manual, may create shock, fire, X-radiation or other hazards.

LOCATION OF USER'S CONTROL

Front Panel

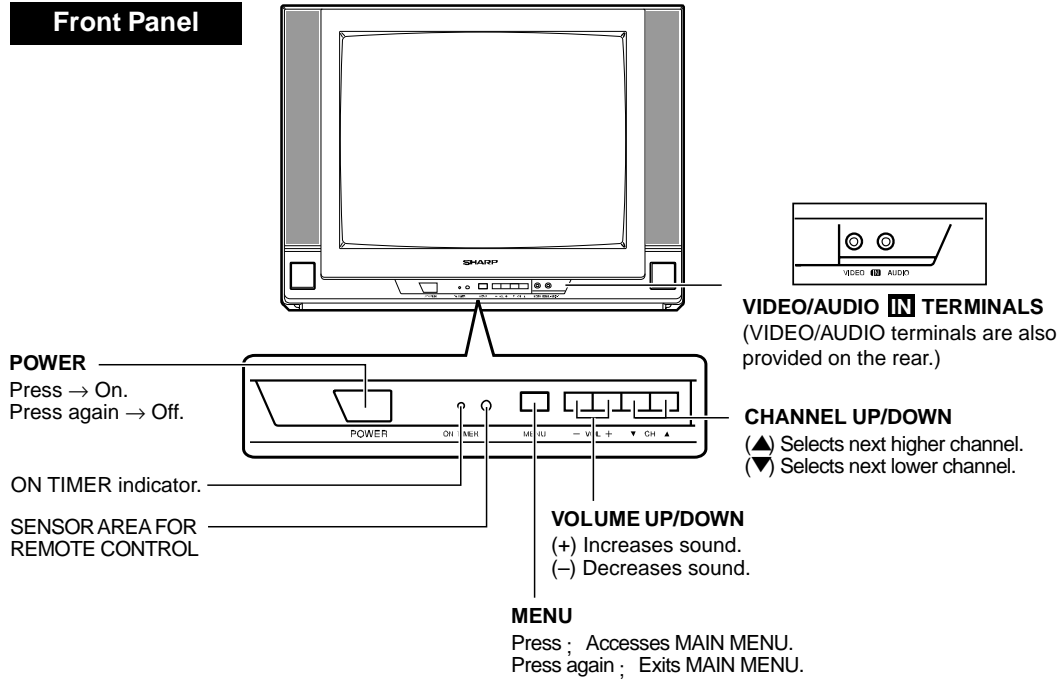

Basic Remote Control Functions

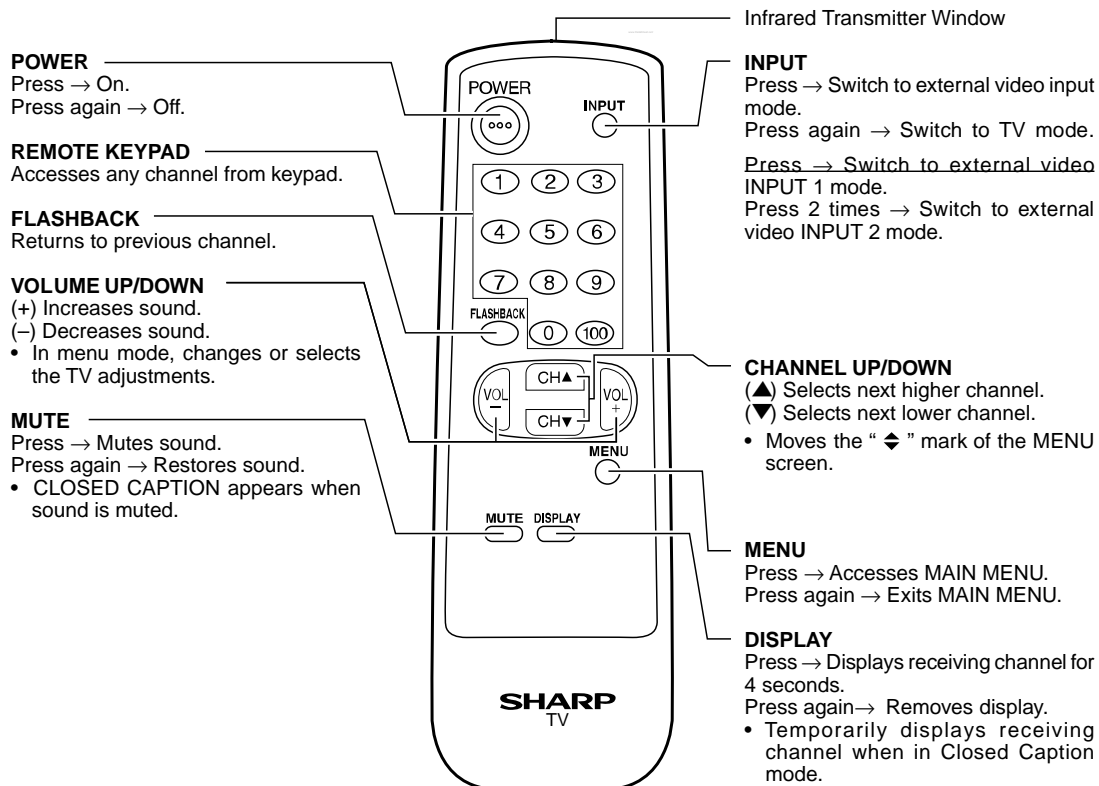

INSTALLATION AND SERVICE INSTRUCTIONS

- Note:** (1) When performing any adjustments to resistor controls and transformers use non-metallic screwdrivers or TV alignment tools.
 (2) Before performing adjustments, the TV set must be on at least 15 minutes.

CIRCUIT PROTECTION

The receiver is protected by a 3.15A fuse (F701), mounted on PWB-A, wired into one side of the AC line input.

+B DC REGULATOR CONFIRMATION

The + B DC output voltage adjustment is not included in this circuit. However, should confirmation be required proceed as follows.

1. Actuate receiver with 220V AC input voltage.
2. Receive a local channel.
3. Connect positive lead of digital voltmeter to C754 positive side on PWB-A ; negative lead to chassis ground.
4. Confirm this voltage reading is as below.

CAUTION: The reading should be within $+130.0 \pm 2.0V$ DC to ensure normal function and circuitry reliability.

X-RADIATION PROTECTOR CIRCUIT TEST

After service has been performed on the horizontal deflection system, high voltage system, B+ system, test the X-Radiation protection circuit to ascertain proper operation as follows:

1. Apply 220V AC using a variac transformer for accurate input voltage.
2. Allow for warm up and adjust all customer controls for normal picture and sound.
3. Receive a good local channel.
4. Connect a digital voltmeter to TP653 and make sure that the voltmeter reads $21.4 \pm 1.5 V$.
5. Apply external 27.9V DC at TP653 by using an external DC supply, TV must be shut off.
6. To reset the protector, unplug the AC cord and make a short circuit between TP651 and TP652. Now make sure that normal picture appears on the screen.
7. If the operation of the horizontal oscillator does not stop in step 5, the circuit must be repaired before the set is returned to the customer.

HIGH VOLTAGE CHECK

High voltage is not adjustable but must be checked to verify that the receiver is operating within safe and efficient design limitations as specified checks should be as follows:

1. Connect an accurate high voltage meter between ground and anode of picture tube.
2. Operate receiver for at least 15 minutes at 110~220V AC line voltage, with a strong air signal or a properly tuned in test signal.
3. Receive a good local channel.
4. The voltage should be approximately, 25.5kV (at picture MAX Bright center condition).
If a correct reading cannot be obtained, check circuitry for malfunctioning components.

For adjustments of this model, the bus data is converted to various analog signals by the D/A converter circuit.

Note: There are still a few analog adjustments in this series such as focus and master screen voltage. Follow the steps below whenever the service adjustment is required. See "Table-B" to determine, if service adjustments are required.

1. Service mode

Before putting unit into the service mode, check that customer adjustments are in the normal mode. Use the reset function in the video adjustment menu to ensure customer controls are in their proper (reset) position.

2. Service item selection

Once in the service mode, press the Ch-up or Ch-down button on the remote controller or at the set. The service adjustment item will vary in increments of one. Select the item you wish to adjust.

3. Data number selection

Press the Vol-up or down button to adjust the data number.

To enter the service mode and exit service mode.

Short JA137&JA138 for 1 Second and release to switch to the service mode position, and the microprocessor is in input mode.(Adjustment through the I²C bus control.) To exit the service mode, turn the television off by pressing the power button.

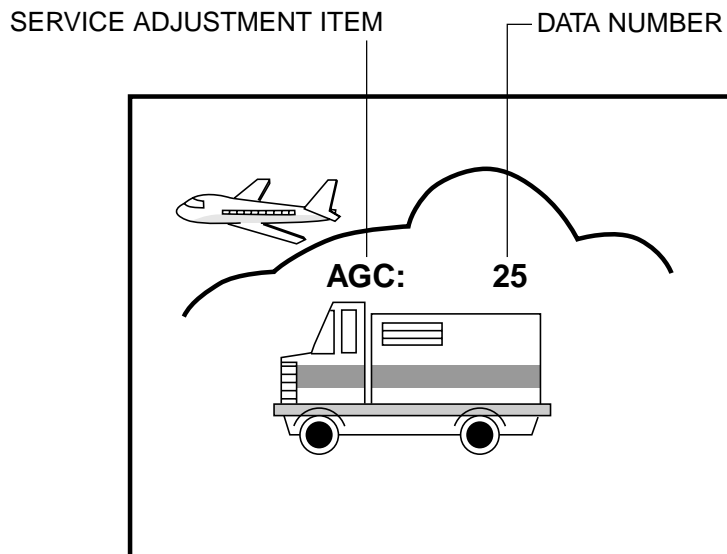
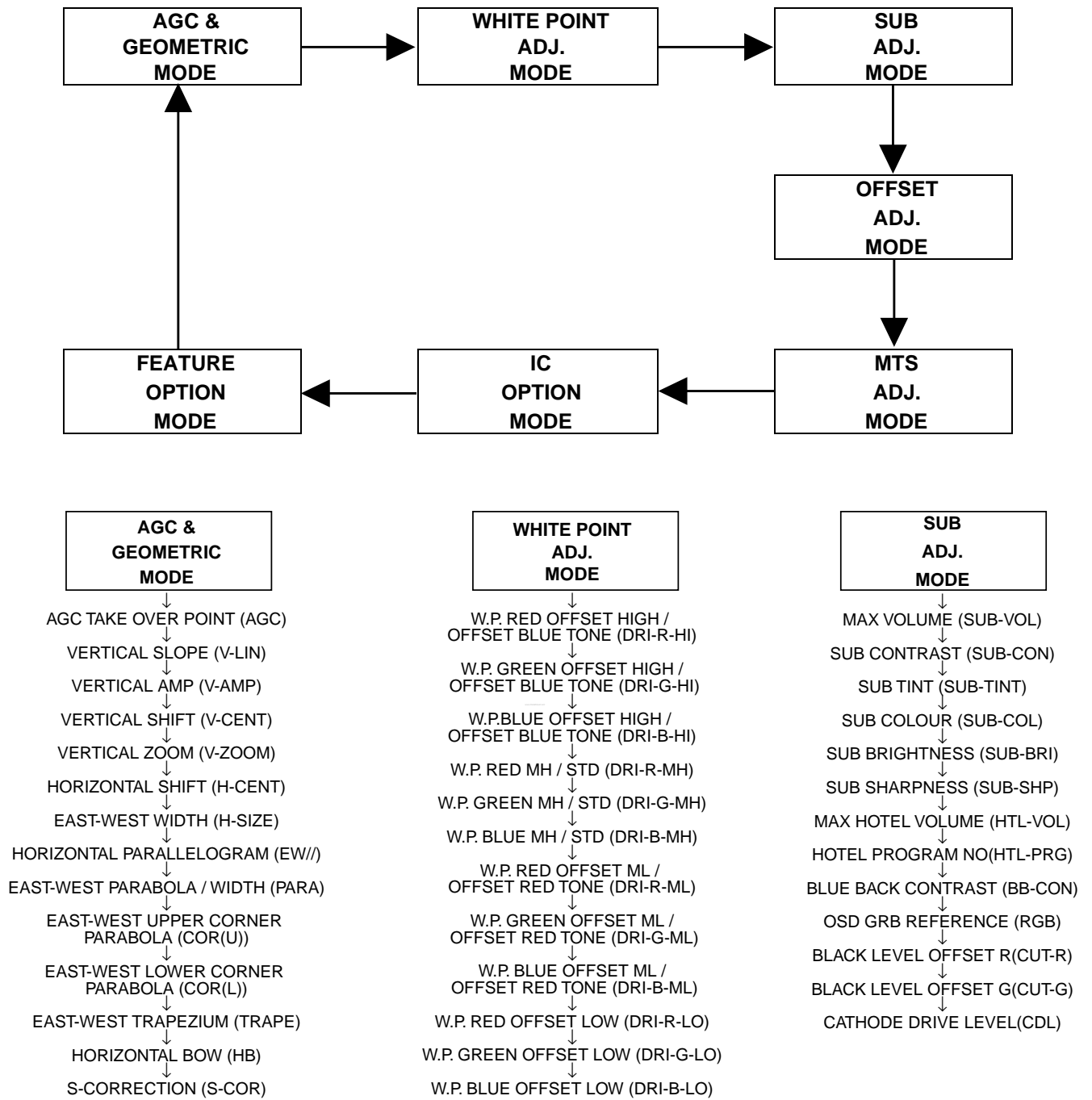

Figure A.

■ SERVICE MODE

(1) In the Service Mode, Key is used to select the mode in the following order.



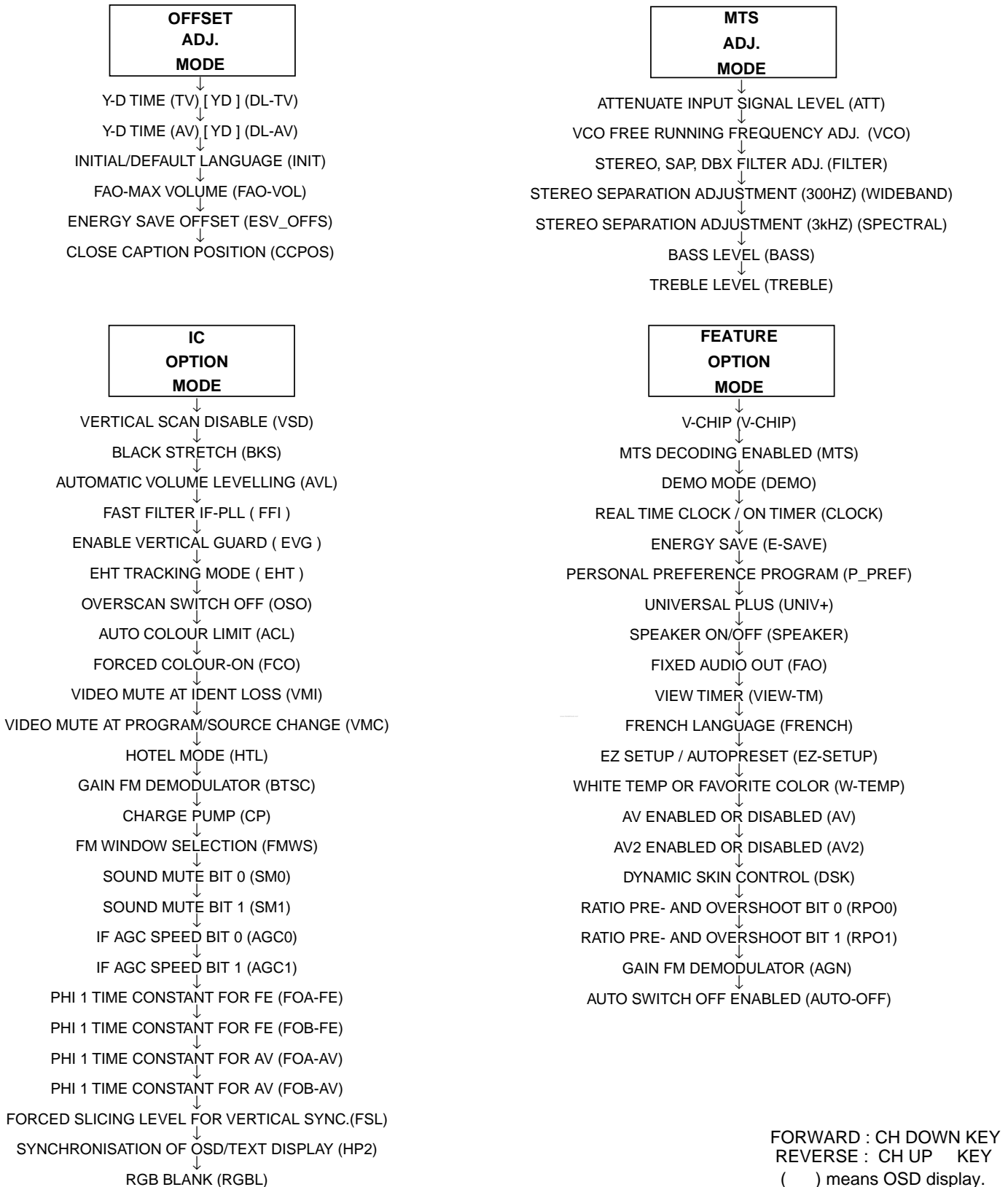

Figure B: ADJUSTMENT CATEGORIES

- ① Press the CH DOWN/UP key on the remote controller to get ready to select the mode one by one.
 - ② Press the CH DOWN/UP key on the remote controller to select the modes reversibly one by one.
 - ③ Using the VOLUME UP/DOWN key on the remote controller, the data can be modified.
- (OSD disturbance can be erased by R/C display key)**

SERVICE MODE

SERVICE POSITION	ADJUST ITEM	DATA			REMARK
		RANGE	INITIAL VALUE	FIX/ADJ	
AGC	AGC TAKE OVER POINT	0~63	14	ADJ	
V-LIN	VERTICAL SLOPE	0~63	32	ADJ	
V-AMP	VERTICAL AMP	0~63	32	ADJ	
V-CENT	VERTICAL SHIFT	0~63	32	ADJ	
V-ZOOM	VERTICAL ZOOM	0~63	32	FIX	
H-CENT	HORIZONTAL SHIFT	0~63	32	ADJ	
H-SIZE	EAST-WEST WIDTH	0~63	32	FIX	
EW//	HORIZONTAL PARALLELOGRAM	0~63	32	FIX	
PARA	EAST-WEST PARABOLA / WIDTH	0~63	32	FIX	
COR(U)	EAST-WEST UPPER CORNER PARABOLA	0~63	32	FIX	
COR(L)	EAST-WEST LOWER CORNER PARABOLA	0~63	32	FIX	
TRAPE	EAST-WEST TRAPEZIUM	0~63	32	FIX	
HB	HORIZONTAL BOW	0~63	32	FIX	
S-COR	S-CORRECTION	0~63	0	FIX	must be "17"
DRI-R-HI	"W,P RED OFFSET HIGH / OFFSET BLUE TONE"	0~63	32	FIX	must be "32"
DRI-G-HI	W.P. GREEN OFFSET HIGH / OFFSET BLUE TONE	0~63	32	FIX	must be "33"
DRI-B-HI	W.P.BLUE OFFSET HIGH / OFFSET BLUE TONE	0~63	32	FIX	must be "37"
DRI-R-MH	W.P. RED MH / STD	0~63	25	FIX	must be "32"
DRI-G-MH	W.P. GREEN MH / STD	0~63	32	ADJ	
DRI-B-MH	W.P. BLUE MH / STD	0~63	32	ADJ	
DRI-R-ML	W.P. RED OFFSET ML / OFFSET RED TONE	0~63	32	FIX	must be "32"
DRI-G-ML	W.P. GREEN OFFSET ML / OFFSET RED TONE	0~63	32	FIX	must be "32"
DRI-B-ML	W.P. BLUE OFFSET ML / OFFSET RED TONE	0~63	32	FIX	must be "25"
DRI-R-LO	W.P. RED OFFSET LOW	0~63	32	FIX	must be "32"
DRI-G-LO	W.P. GREEN OFFSET LOW	0~63	32	FIX	must be "22"
DRI-B-LO	W.P. BLUE OFFSET LOW	0~63	32	FIX	must be "19"
SUB-VOL	MAX VOLUME	0~63	63	FIX	must be "63"
SUB-CON	SUB CONTRAST	0~63	63	FIX	must be "54"
SUB-COL	SUB COLOUR	0~63	32	ADJ	
SUB-BRI	SUB BRIGHTNESS	0~63	32	ADJ	
SUB-TINT	SUB TINT	0~63	32	ADJ	
SUB-SHP	SUB SHARPNESS	0~63	32	FIX	must be "27"
HTL-VOL	MAX HOTEL VOLUME	0~63	32	FIX	
HTL-PRG	HOTEL PROGRAM NO	0~125 or >125 for none	255	FIX	
BB-CON	BLUE BACK CONTRAST	0~15	10	FIX	must be "5"
RGB	OSD GRB REFERENCE	0~15	15	FIX	must be "5"
CUT-R	BLACK LEVEL OFFSET R	0~63	32	ADJ	
CUT-G	BLACK LEVEL OFFSET G	0~63	32	ADJ	
CDL	CATHODE DRIVE LEVEL	0~15	0	FIX	must be "6"
DL-TV	Y-D TIME (TV) [YD]	0~15	12	FIX	must be "2"
DL-AV	Y-D TIME (AV) [YD]	0~15	12	FIX	must be "8"
INIT	INITIAL/DEFAULT LANGUAGE	0(English), 1(Spanish), 2(French)	0	FIX	must be "1"
FAO-VOL	FAO-MAX VOLUME	0~63	63	FIX	must be "63"
ESV_OFFS	ENERGY SAVE OFFSET	0~63	10	FIX	must be "20"
CCPOS	CLOSE CAPTION POSITION	0~255	32	ADJ	
ATT	ATTENUATE INPUT SIGNAL LEVEL	0~15	10	FIX*	
VCO	VCO FREE RUNNING FREQUENCY ADJ.	0~63	32	FIX*	
FILTER	"STEREO, SAP, DBX FILTER ADJ. "	0~63	28	FIX*	
WIDEBAND	STEREO SEPARATION ADJUSTMENT (300HZ)	0~63	32	FIX*	
SPECTRAL	STEREO SEPARATION ADJUSTMENT (3kHz)	0~63	27	FIX*	
BASS	BASS LEVEL	0~15	8	FIX	
TREBLE	TREBLE LEVEL	0~15	8	FIX	
VSD	VERTICAL SCAN DISABLE	0 or 1 when item selected	0	FIX	
BKS	BLACK STRETCH	0(disable) or1(enable)	1	FIX	
AVL	AUTOMATIC VOLUME LEVELLING	0(disable) or1(enable)	1	FIX	
FFI	FAST FILTER IF-PLL	0(disable) or1(enable)	0	FIX	
EVG	ENABLE VERTICAL GUARD	0(disable) or1(enable)	1	FIX	
EHT	EHT TRACKING MODE	0(disable) or1(enable)	1	FIX	
OSO	OVERSCAN SWITCH OFF	0(disable) or1(enable)	0	FIX	
ACL	AUTO COLOUR LIMIT	0(disable) or1(enable)	0	FIX	
FCO	FORCED COLOUR-ON	0(disable) or1(enable)	0	FIX	
VMI	VIDEO MUTE AT IDENT LOSS	0(disable) or1(enable)	1	FIX	
VMC	VIDEO MUTE AT PROGRAM/SOURCE CHANGE	0(disable) or1(enable)	1	FIX	
HTL	HOTEL MODE	0(disable) or1(enable)	0	FIX	
BTSC	GAIN FM DEMODULATOR	0(disable) or1(enable)	0	FIX	
CP	CHARGE PUMP	0(fast tuning) or 1 (moderate speed tuning)	0	FIX	

Table - A

SERVICE POSITION	ADJUST ITEM	DATA			REMARK
		RANGE	INITIAL VALUE	FIX/ADJ	
FMWS	FM WINDOW SELECTION	0(disable) or1(enable)	0	FIX	
SM0	SOUND MUTE BIT 0 (SM0)	0(disable) or1(enable)	1	FIX	
SM1	SOUND MUTE BIT 1	0(disable) or1(enable)	0	FIX	
AGC0	IF AGC SPEED BIT 0	0(disable) or1(enable)	1	FIX	
AGC1	IF AGC SPEED BIT 1	0(disable) or1(enable)	0	FIX	
FOA-FE	PHI 1 TIME CONSTANT FOR FE	0(disable) or1(enable)	0	FIX	
FOB-FE	PHI 1 TIME CONSTANT FOR FE	0(disable) or1(enable)	0	FIX	
FOA-AV	PHI 1 TIME CONSTANT FOR AV	0(disable) or1(enable)	1	FIX	
FOB-AV	PHI 1 TIME CONSTANT FOR AV	0(disable) or1(enable)	1	FIX	
FSL	FORCED SLICING LEVEL FOR VERTICAL SYNC.	0(disable) or1(enable)	0	FIX	
HP2	SYNCHRONISATION OF OSD/TEXT DISPLAY	0(disable) or1(enable)	0	FIX	
RGBL	RGB BLANK	0(disable) or1(enable)	0	FIX	
V-CHIP	V-CHIP	0(disable) or1(enable)	0	FIX	
MTS	MTS DECODING ENABLED	0(disable) or1(enable)	0	FIX*	
DEMO	DEMO MODE	0(disable) or1(enable)	1	FIX	
CLOCK	REAL TIME CLOCK / ON TIMER	0(disable) or1(enable)	1	FIX	must be "1"
E-SAVE	ENERGY SAVE	0(disable) or1(enable)	1	FIX	
P_PREF	PERSONAL PREFERENCE PROGRAM	0(disable) or1(enable)	0	FIX	
UNIV+	UNIVERSAL PLUS	0(disable) or1(enable)	0	FIX	
SPEAKER	SPEAKER ON/OFF	0(disable) or1(enable)	0	FIX	
FAO	FIXED AUDIO OUT	0(disable) or1(enable)	0	FIX	
VIEW-TM	VIEW TIMER	0(disable) or1(enable)	1	FIX	must be "1"
FRENCH	FRENCH LANGUAGE	0(disable) or1(enable)	0	FIX	
EZ-SETUP	EZ SETUP / AUTOPRESET	0(AUTOPRESET) or 1(EZ SETUP)	1	FIX	
W-TEMP	WHITE TEMP OR FAVORITE COLOR	0(FC) or 1(WT)	0	FIX	
AV	AV ENABLED OR DISABLED	0(without ext. source) or 1(with external source)	0	FIX	
AV2	AV2 ENABLED OR DISABLED	0(1 input) or 1(2 input)	0	FIX*	
DSK	DYNAMIC SKIN CONTROL	0(disable) or1(enable)	0	FIX	
RPO0	RATIO PRE- AND OVERSHOOT BIT 0	0(disable) or1(enable)	0	FIX	
RPO1	RATIO PRE- AND OVERSHOOT BIT 1	0(disable) or1(enable)	0	FIX	
AGN	GAIN FM DEMODULATOR	0(normal) or1(+6dB)	0	FIX	
AUTO-OFF	AUTO SWITCH OFF ENABLED	0(disable) or1(enable)	1	FIX	
PON-CH		0(disable) or1(enable)	0	FIX	

Table - A

Holding down to short JA137 & JA138 and turn on the main power SW will automatically write the initial values into IC1003.

This is only can done when a new EEPROM is used. (Judge with the first 4 bytes.)

PART REPLACED	ADJUSTMENT		NOTES
	NECESSARY	UNNECESSARY	
IC801		X	Data is stored in IC1003.
IC1003	X		Holding down to short JA137 & JA138 and turn on the main power SW will automatically write the initial values into IC1003. This is only can done when a new EEPROM is used. (Judge with the first 4 bytes.)
CRT	X		Adjust items related to picture tube only.

Table - B

■ SERVICE ADJUSTMENT

RF AGC Adjustment

1. Receive a good local channel.
2. Enter the service mode signal category and select the service adjustment "AGC".
3. Set the data value to point where no noise or beat appears.
4. Select another channel to confirm that no noise or beat appears.



CHROMA ADJUSTMENT

No.	Adjusting point	Adjusting procedure/conditions	Waveform and others
1	SUB-TINT (I²C BUS CONTROL)	<ol style="list-style-type: none"> 1. Receive the "Colour Bar" signal through AV in. 2. Connect the oscilloscope to TP853 (Pin (5) of P882) BLUE-OUT. <ul style="list-style-type: none"> • Range : 100mV/div. (AC)(Use Probe 10:1) • Sweep time : 10 μsec/div. 3. Call the "SUB-TINT" mode in service mode. Adjust the "SUB-TINT" bus data to obtain the waveform shown as Fig 1. 4. "SUB-TINT" bus data decrease 4 steps to get final waveform. (Fig 2.) 5. Clear the SERVICE mode. 	<p>Fig 1</p> <p>Fig 2</p>

HORIZONTAL AND VERTICAL DEFLECTION LOOP ADJUSTMENT

No.	Adjusting point	Adjusting procedure/conditions	Waveform and others
1	V-SLOPE(I²C BUS CONTROL)	<ol style="list-style-type: none"> 1. Receive Monoscope Pattern Signal. 2. Call the "V-LIN" mode. 3. Increase or decrease "V-LIN" by Volume key till the horizontal line in the center of monoscope is just at the position where the blanking starts. 	
2	V-CENTER (I²C BUS CONTROL)	<ol style="list-style-type: none"> 1. Call the "V-CENT" mode. 2. Increase or decrease "V-CENT" by Volume key till the picture is centered. 	
3	V - AMP (I²C BUS CONTROL)	<ol style="list-style-type: none"> 1. Call the "V-AMP" mode. 2. Increase or decrease "V - AMP" by Volume key to set overscan of 10.0% typical. Adjustment Spec 10.0% range ±1%. 	
4	S-CORRECTION (I²C BUS CONTROL)	FIXED DATA, NO NEED TO ADJUST.	
5	H - CENTER	<ol style="list-style-type: none"> 1. Call the "H-CENT" mode. 2. Increase or decrease "H-CENT" by Volume key to center the picture horizontal. 	
6	Focus adjustment	<ol style="list-style-type: none"> 1. Receive the "Monoscope Pattern" signal. 2. Press R/C to set Picture NORMAL condition. 3. Adjust the focus control to get the best focus. 	

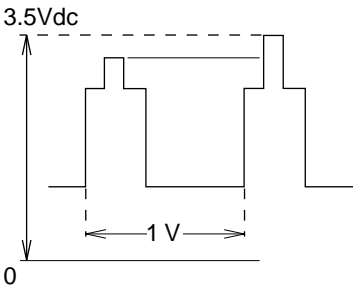
CRT CUT-OFF, BACKGROUND AND SUB-CONTRAST ADJUSTMENT

No.	Adjusting point	Adjusting procedure/conditions	Waveform and others
1	CRT CUTOFF ADJUSTMENT (I²C BUS CONTROL)	1. Switch TV to VIDEO mode, BLUE BACK OFF, with NO VIDEO signal. 2. Press R/C to set Picture Normal condition. 3. Connect the oscilloscope to Red OUT from IC801.(TP47R) <div style="text-align: center;"> Range : 1 V/Div (DC) Sweep : 5 msec/Div </div> 4. Adjust SCREEN VR ,so that the tip of signal reach 3.5 Vdc + 0.1 Vdc.	
2	SUB-BRIGHTNESS ADJUSTMENT (I²C BUS CONTROL)	1. Call " SUB-BRI" in service mode. (Receive Cross-hatch pattern with 5 black level windows) 2. Adjust the " SUB BRIGHT " bus data in order that the line 1, 2 and 3 have the same darkness wherelse line 4 is slightly brighter than line 1, 2 and 3 and finally line 5 will be the brighter than line 4.	 <p>1, 2, 3 are in same black level.</p>
3	WHITE BALANCE SERVICE MODE ADJ. (I²C BUS CONTROL)	1. Receive the "Monoscope Pattern" signal. 2. Press R/C to set Picture NORMAL condition. 3. Connect the DC miliammeter between the TP 602 (-) TP 603 (+). 4. Check Beam current should be around (990µA) 5. Set it to service mode and adjust the DRI-G-MH, & DRI-B-MH data to have a colour temperature of 11,600°K (white). 6. Receive "WHITE" pattern, WITH BURST signal, and set BRIGHTNESS Y by generator, to ** 10 cd/m ² (MINOLTA CA-100) by reducing LUMINATE Y signal. 7. Adjust "CUT-R" & "CUT-G" to get 11,600°K. Then go back NORMAL mode (HIGH BRIGHT**) to check colour temperature. If out of range, back to (1). Note: This adjustment must be done after warming up the unit for 30 minutes or longer with a beam current over 500µA. <div style="border: 1px solid black; padding: 5px; width: fit-content;"> DRI-R-MH=32 (FIXED) DRI-G-MH=33 (FIXED) DRI-B-MH=37 (FIXED) DRI-R-MH=32 (FIXED) </div>	# 11,600° K X : 0.273 Y : 0.280 (MINOLTA COLOUR ANALYZER CA-100) *NOTE: Above DATA can be UP/DOWN by volume key. <div style="text-align: center;"> LOW HIGH 20" 1.8cd/m² 115cd/m² </div> * 11,600° K DRI-GW="DRI-GS"DATA-5 DRI-BW="DRI-BS" DATA-5
4	Maximum beam check	1. Receive the "Monoscope Pattern" signal. 2. Press R/C to set Picture NORMAL condition. 3. Connect the DC miliammeter between TP603 (+) and TP602 (-). (Full Scale: 3 mA Range) 4. Beam current must be within 990 ± 50 µA.	

MODEL 20SL43 CHASSIS LAYOUT

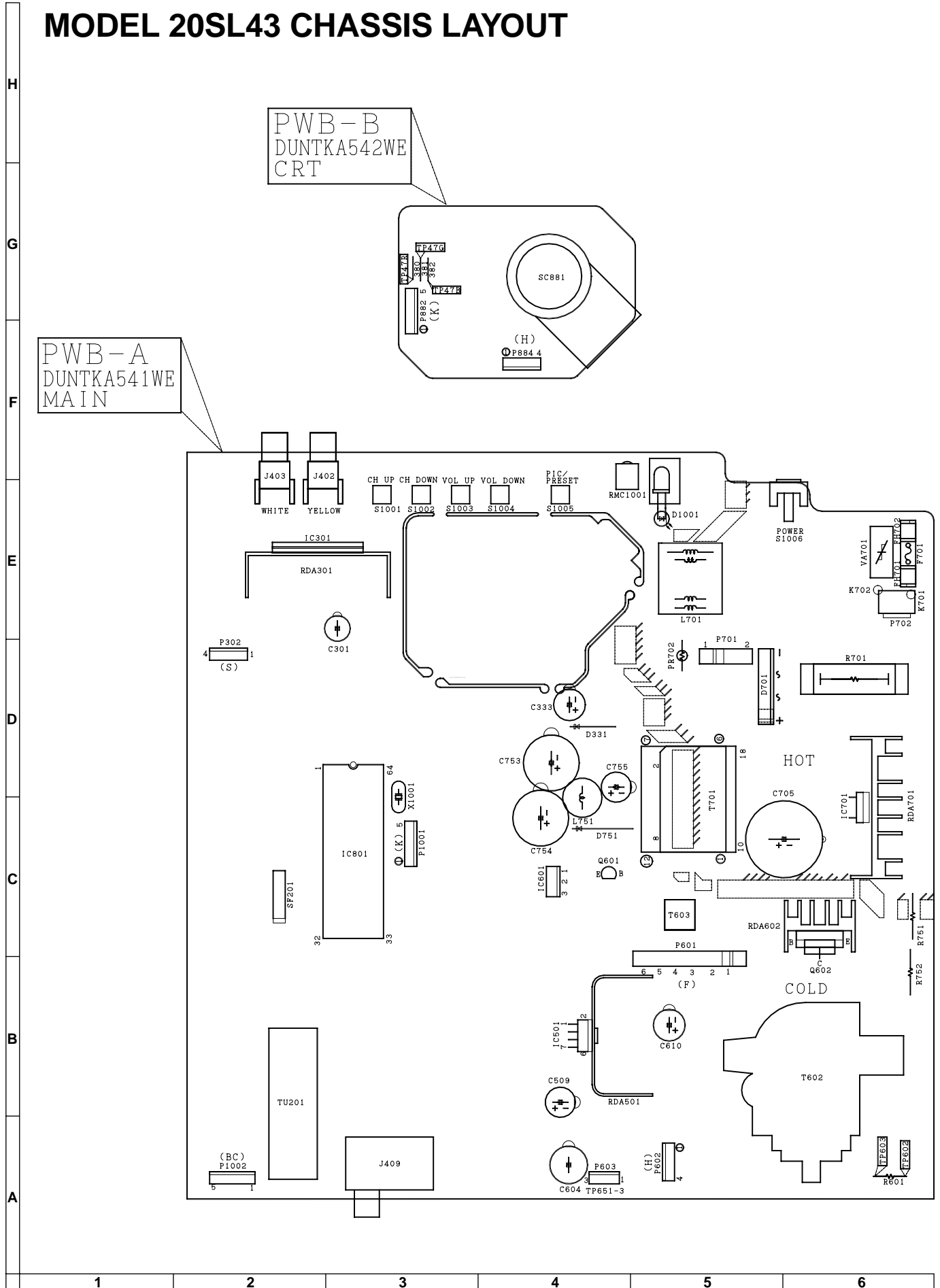

BLOCK DIAGRAM-1

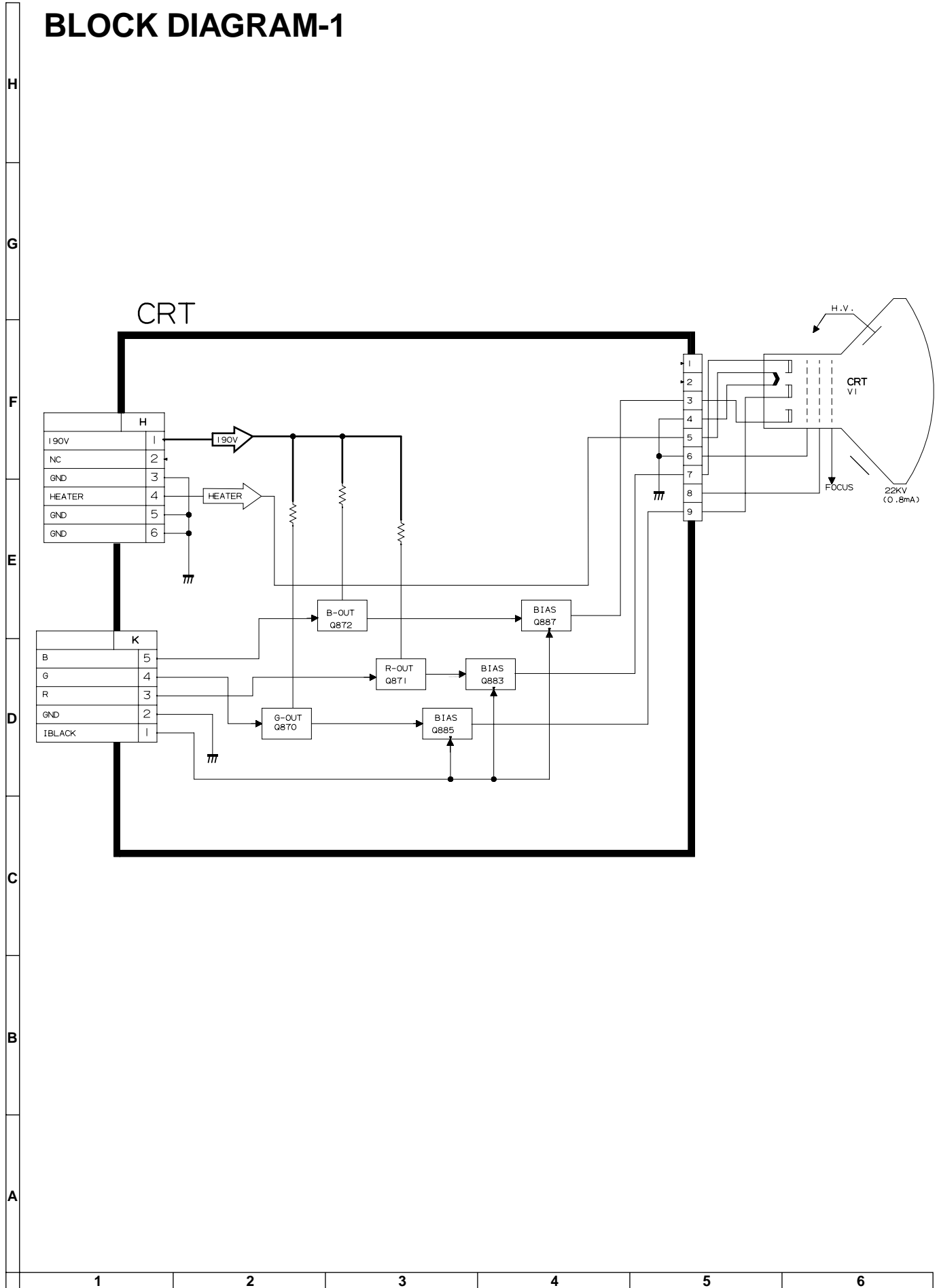

MODEL 20SL43 BLOCK DIAGRAM-2

MAIN

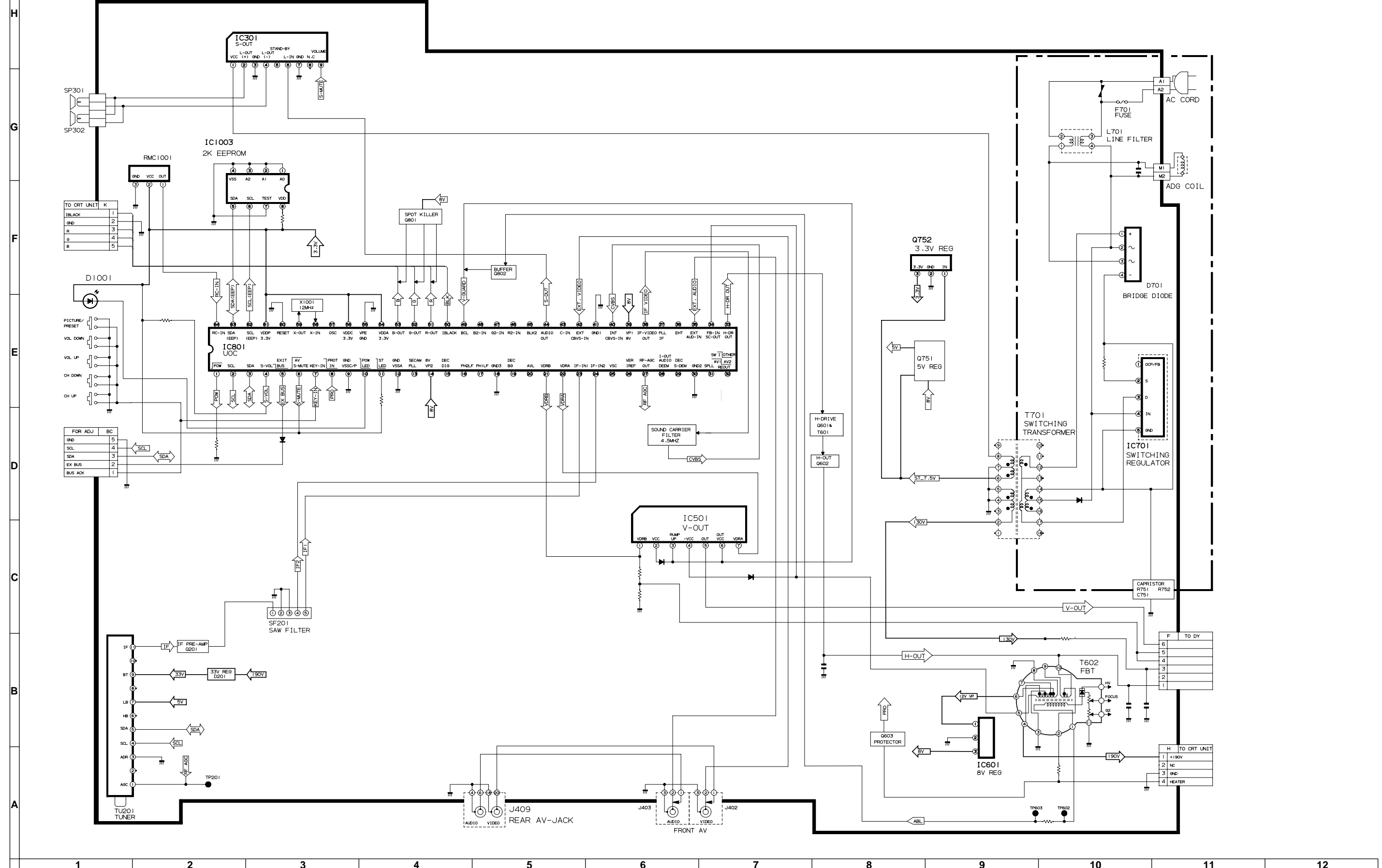

DESCRIPTION OF SCHEMATIC DIAGRAM

NOTES:

1. The unit of resistance "ohm" is omitted.
($K=k\Omega=1000\Omega$, $M=M.\Omega$)
2. All resistors are 1/16 watt, unless otherwise noted.
3. All capacitors are μF , unless otherwise noted.
($P=pF=\mu\mu F$)
4. (G) indicates $\pm 2\%$ tolerance may be used.
5. \perp indicates line isolated ground.
6. \downarrow indicates hot ground.

VOLTAGE MEASUREMENT CONDITIONS:

1. All DC voltages are measured with DVM connected between points indicated and chassis ground, line voltage set at 120V AC and all controls set for normal picture unless otherwise indicated.
2. All voltages measured with 1000 μ V B & W or Color signal.

WAVEFORM MEASUREMENT CONDITIONS:

1. Photographs taken on a standard gated color bar signal, the tint setting adjusted for proper color. The wave shapes at the red, green and blue cathodes of the picture tube depend on the tint, color level and picture control.
2. \odot indicates waveform check points (See chart, waveforms are measured from point indicated to chassis ground.)

\triangle AND SHADED () COMPONENTS
= SAFETY RELATED PARTS.
 \blacktriangle MARK= X-RAY RELATED PARTS.

This circuit diagram is a standard one, printed circuits may be subject to change for product improvement without prior notice.

WAVEFORMS

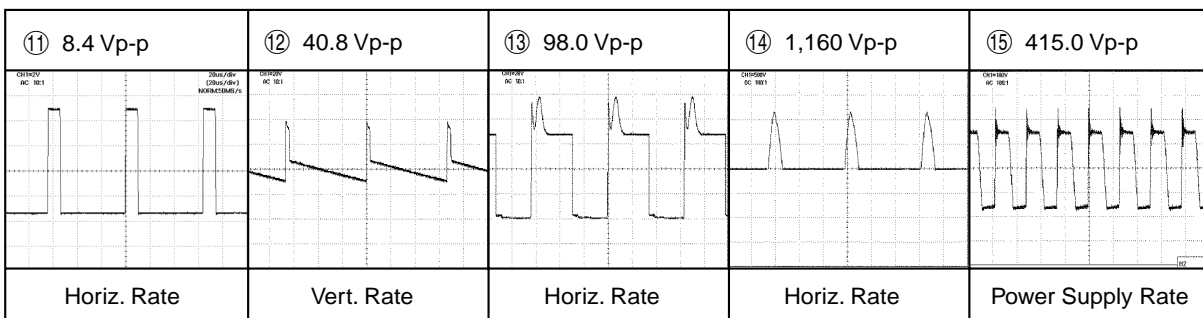
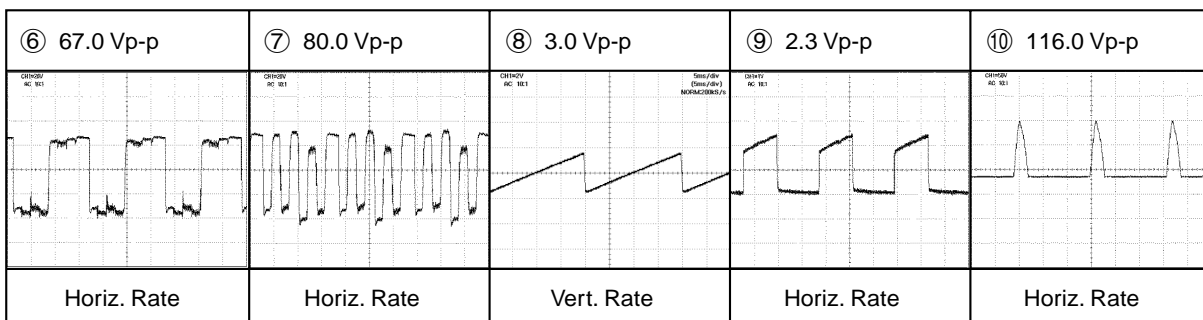
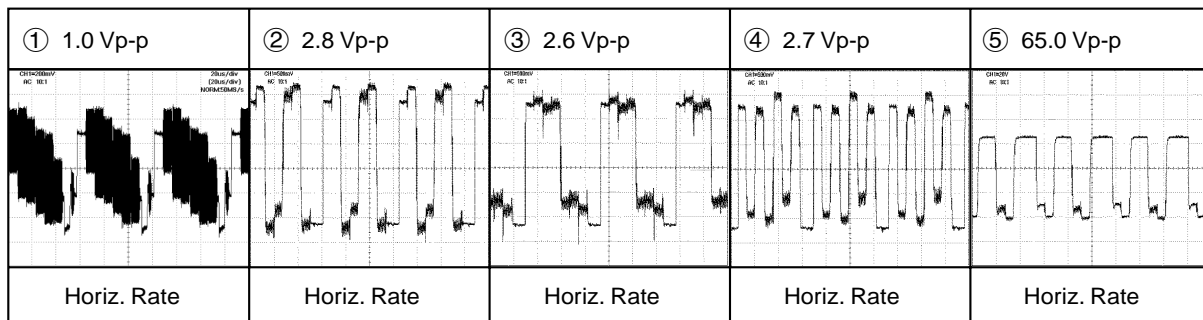

MODEL 20SL43 BLOCK DIAGRAM-2

20SL43

MAIN

NOTE 1: THE UNIT OF RESISTANCE *OHM* IS OMITTED
 (1K=1000 OHMS; 1M=1000000)
 2. ALL RESISTORS ARE 1/8WATT UNLESS OTHERWISE NOTED.
 3. UNIT OF ALL CAPACITORS ARE F WITH PREFIX SYMBOL
 (u, p, ETC.).

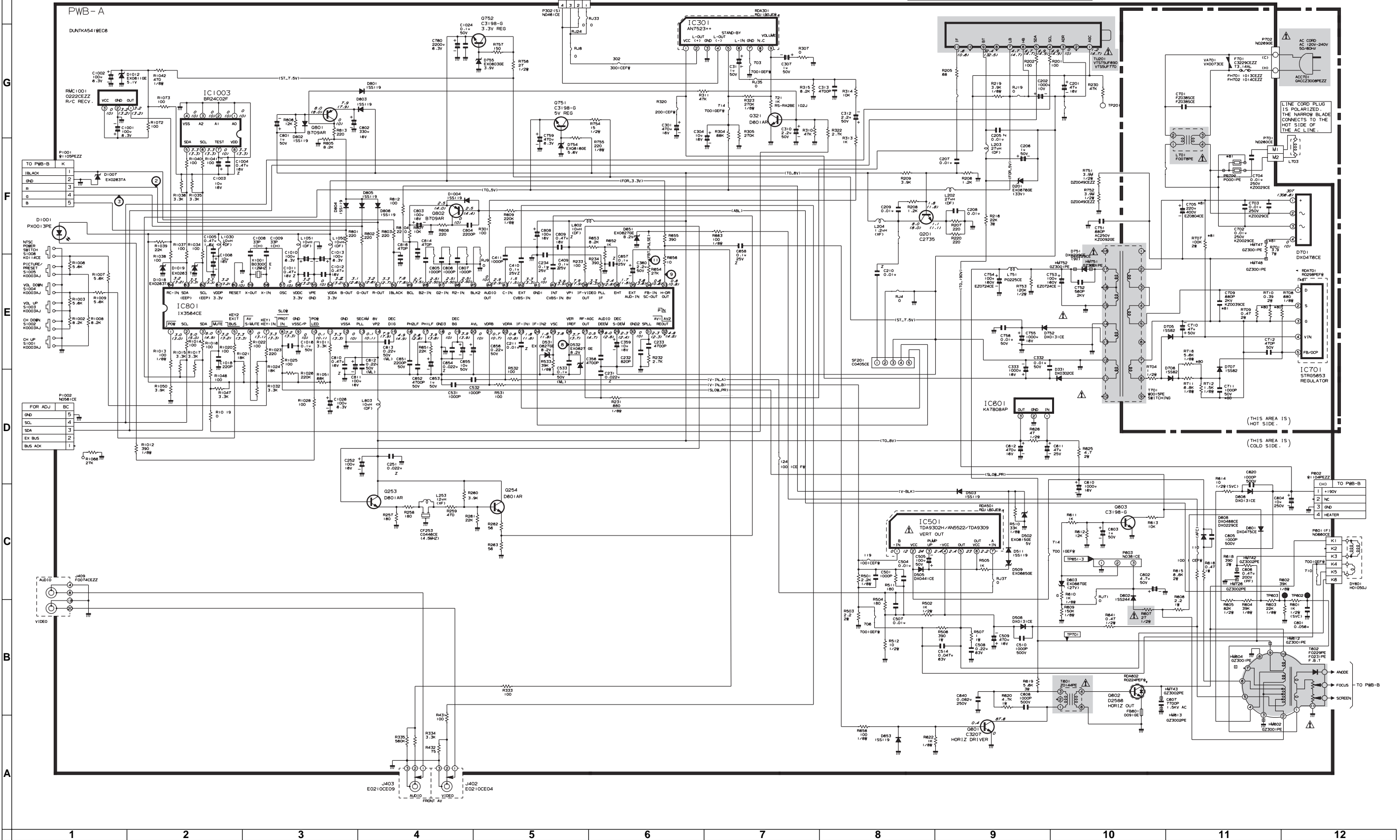

SCHEMATIC DIAGRAM: CRT Unit

H

G

F

E

D

C

B

A

NOTE: 1. THE UNIT OF RESISTANCE "OHM" IS OMITTED
(K=1000 OHMS, M=MEGAOHM).
2. ALL RESISTORS ARE 1/16 WATT UNLESS OTHERWISE NOTED.
3. UNIT OF ALL CAPACITORS ARE F WITH PREFIX SYMBOL
(u, P, ETC).

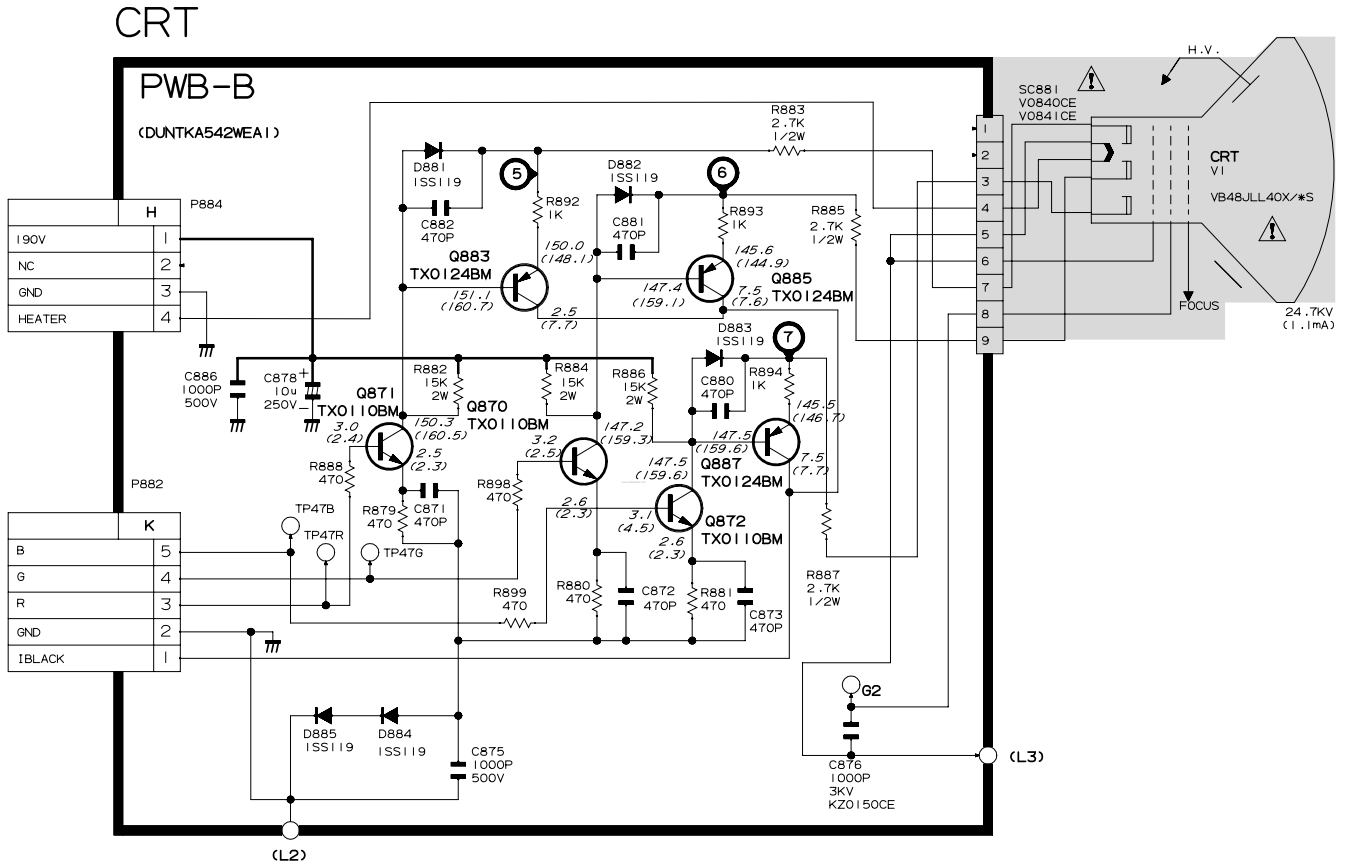

1

2

3

4

5

6

PRINTED WIRING BOARD ASSEMBLIES

H
G
E
D
C
B
A

1 2 3 4 5 6

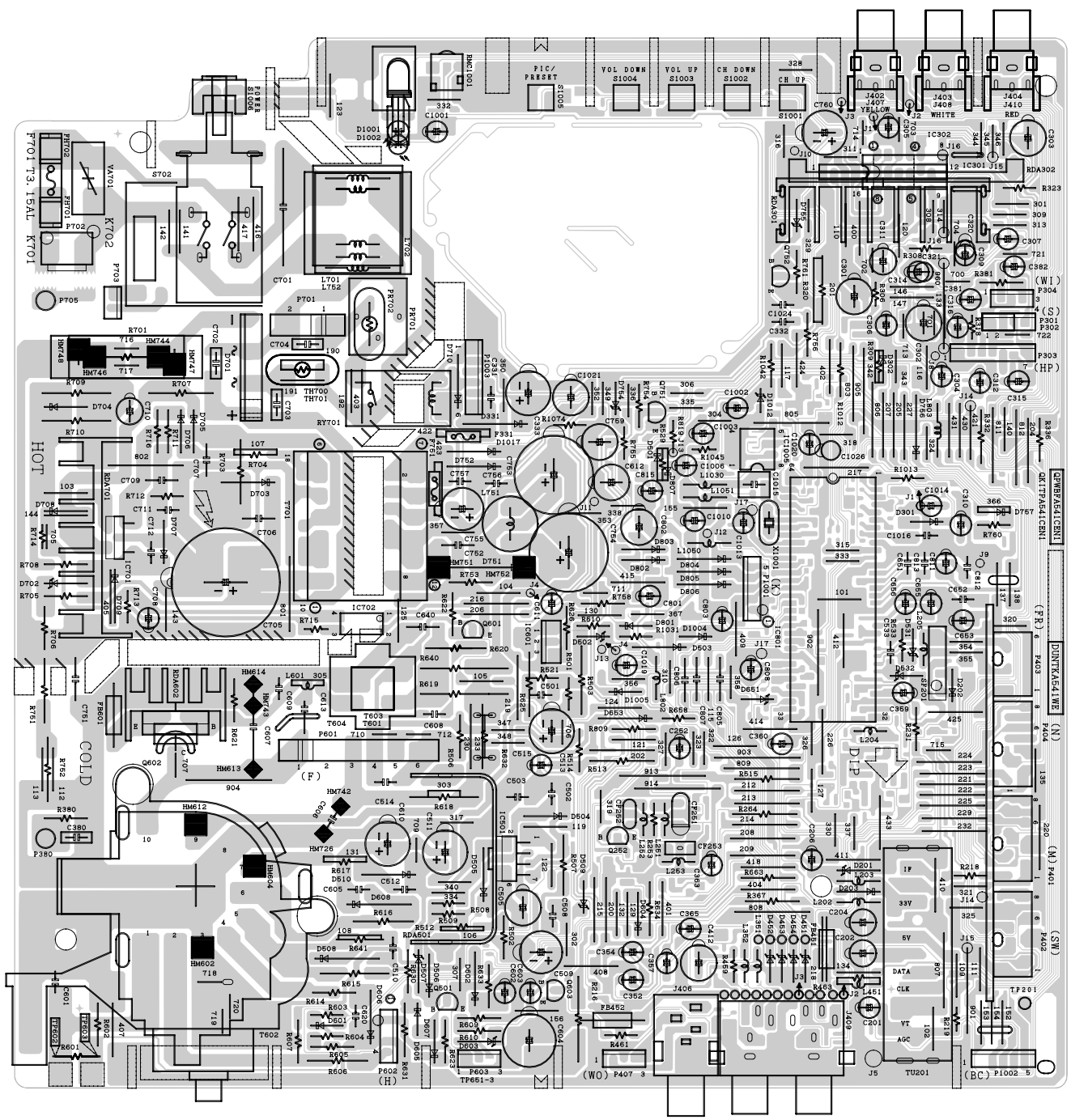

PWB-A: MAIN Unit (Wiring Side)

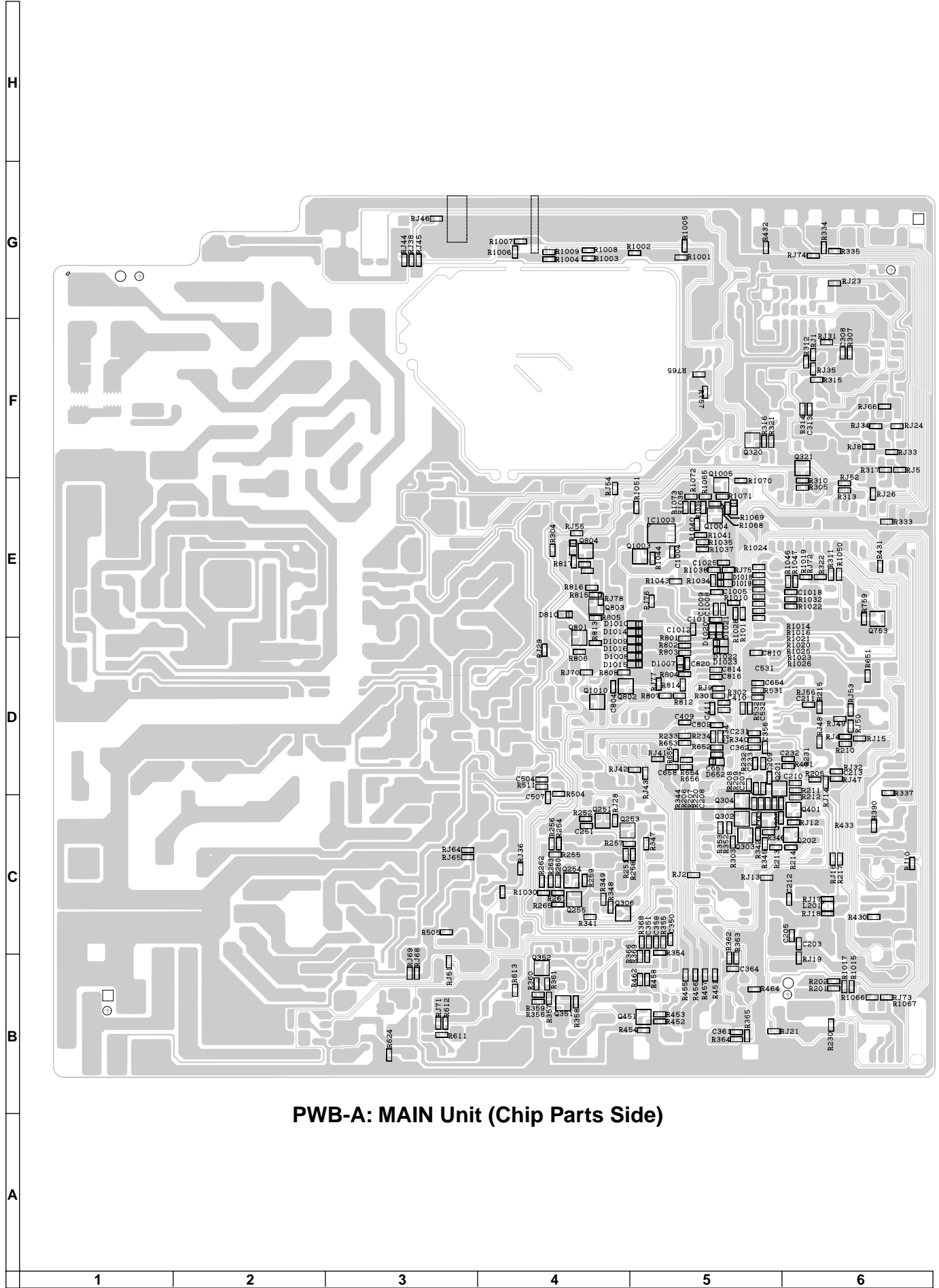

PWB-A: MAIN Unit (Chip Parts Side)

H

G

F

E

D

C

B

A

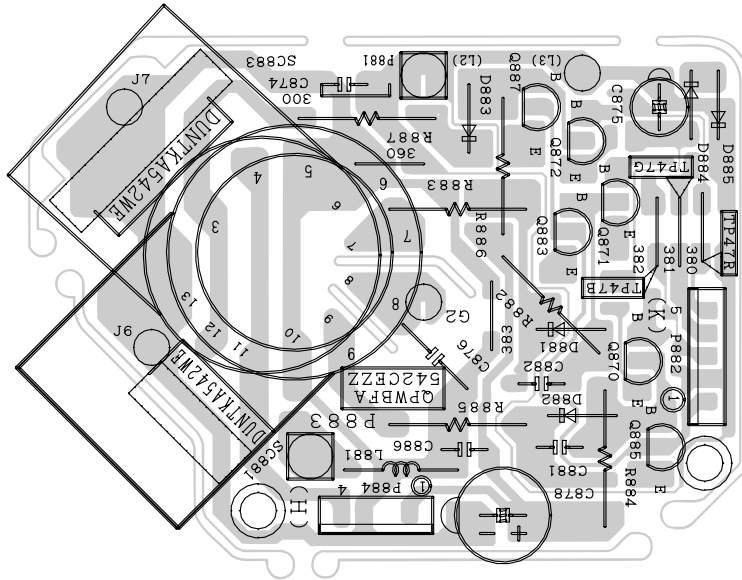

PWB-B: CRT Unit (Wiring Side)

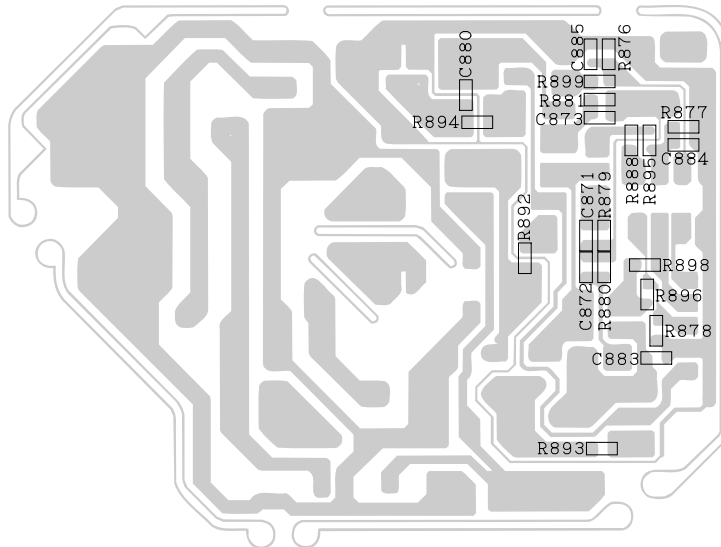

PWB-B: CRT Unit (Chip Parts Side)

1

2

3

4

5

6

PARTS LIST

PARTS REPLACEMENT

Replacement parts which have these special safety characteristics identified in this manual; electrical components having such features are identified by Δ and shaded areas in the Replacement Parts Lists and Schematic Diagrams. The use of a substitute replacement part which does not have the same safety characteristic as the factory recommended replacement parts shown in this service manual may create shock, fire or other hazards.

"HOW TO ORDER REPLACEMENT PARTS"

To have your order filled promptly and correctly, please furnish the following information.

- | | |
|-----------------|----------------|
| 1. MODEL NUMBER | 2. REF. NO. |
| 3. PART NO. | 4. DESCRIPTION |

in **USA**: Contact your nearest SHARP Parts Distributor to order. For location of SHARP Parts Distributor, Please call Toll-Free; 1-800-BE-SHARP

« MARK: SPARE PARTS-DELIVERY SECTION

p MARK: X-RAY RELATED PARTS

Ref. No.	Part No.	★ Description	Code
----------	----------	---------------	------

PICTURE TUBE

Δ	V1	VB48JLL40X/*S	X	CRT 19V (ORION)	BR
Δ	L703	RCILG0074PEZZ	X	Degaussing Coil	AH
Δ	DY601	RCILH0105GJZZ	X	DY (20V)	AQ
		LHLDW0102GJKZ	X	WIRE TIE (20.32 CM)	AB
		PMAGF3045CEZZ	X	PURITY MAGNET	AC
		QEARC2016PEZZ	X	EARTH PARTS	AC
		PSPAG0012MEZZ	X	WEDGE, X3	AB

PRINTED WIRING BOARD ASSEMBLIES (NOT REPLACEMENT ITEM)

PWB-A DUNTKA541WEC6 – MAIN Unit	—
PWB-B DUNTKA542WEB3 – CRT Unit	—

Ref. No.	Part No.	★ Description	Code
----------	----------	---------------	------

PWB-A: DUNTKA541WEC6 MAIN UNIT

TUNER

NOTE: THE PARTS HERE SHOWN ARE SUPPLIED AS AN ASSEMBLY BUT NOT INDEPENDENTLY

Δ	TU201	VTUVT1T5UF214	X	TUNER	AP
INTEGRATED CIRCUITS					
	IC301	VHIAN7523+-1	X	AN7523++	AD
Δ	IC501	VHITDA9302H-1	X	TDA9302H	AE
	IC601	VHIKA7808AP-1	X	KIA7808API	AC
Δ	IC701	VHISTRG5653-1	X	STRG5653	AH
	IC801	RH-IX3564CEN4	X	IX3564CE	AT
	IC1003	VHIBR24C02F1EY	X	BR24C02F-WE2	AC
TRANSISTORS					
	Q201	VS2SC2735//1EY	X	2SC2735	AB
	Q253	VS2SD601AR/-1Y	X	2SD601AR	AB
	Q254	VS2SD601AR/-1Y	X	2SD601AR	AB
	Q321	VS2SD601AR/-1Y	X	2SD601AR	AB
	Q601	VS2SC3207//1+	X	2SC3207-AT	AB
	Q602	VS2SD2586//1E	X	2SD2586	AF
	Q603	VS2SC3198-G-1+	X	2SC3198-G	AB
	Q751	VS2SC3198-G-1+	X	2SC3198-G	AB
	Q752	VS2SC3198-G-1+	X	2SC3198-G	AB
	Q801	VS2SB709AR/-1Y	X	2SB709AR	AB
	Q802	VS2SB709AR/-1Y	X	2SB709AR	AB
DIODES					
	D201	RH-EX0676GEZZY	X	Zener	Diode 32V AB
Δ	D331	RH-DX0302CEZZY	X	Diode	AB
	D502	RH-EX0615GEZZY	X	Zener	Diode, 5.6V AB
	D503	VHD1SS119//1Y	X	Diode	AA
	D505	RH-DX0441CEZZY	X	Diode	AB
	D508	RH-DX0131CEZZY	X	Diode	AB
	D509	RH-EX0665GEZZY	X	Zener	Diode, 5V AB
	D511	VHD1SS119//1Y	X	Diode	AA
	D531	RH-EX0627GEZZY	X	Zener	Diode, 8.2V AB
	D532	RH-EX0627GEZZY	X	Zener	Diode, 8.2V AB
	D601	RH-DX0475CEZZY	X	Diode	AB
	D602	VHD1SS244//1Y	X	Diode	AB
Δ	D603	RH-EX0667GEZZY	X	Zener	Diode 27V AB
Δ	D606	RH-DX0131CEZZY	X	Diode	AB
Δ	D608	RH-DX0468CEZZ	X	Diode	AB
	D651	RH-EX0627GEZZY	X	Zener	Diode, 8.2V AB
	D653	VHD1SS119//1Y	X	Diode	AA
	D701	RH-DX0476CEZZ	X	Diode	AC
	D705	VHD1SS82//1AY	X	Diode	AB
	D706	VHD1SS82//1AY	X	Diode	AB
	D707	VHD1SS82//1AY	X	Diode	AB
Δ	D751	RH-DXA006WJZZ	X	Diode	AB
Δ	D752	RH-DX0131CEZZY	X	Diode	AB
	D754	RH-EX0616GEZZY	X	Zener	Diode 5.6V AB
	D755	RH-EX0603GEZZY	X	Zener	Diode, 3.9V AB
	D801	VHD1SS119//1Y	X	Diode	AA
	D802	VHD1SS119//1Y	X	Diode	AA
	D803	VHD1SS119//1Y	X	Diode	AA
	D804	VHD1SS119//1Y	X	Diode	AA
	D805	VHD1SS119//1Y	X	Diode	AA
	D806	VHD1SS119//1Y	X	Diode	AA
	D1001	RH-PX0013PEZZ	X	LED, ON TIMER	AB
	D1004	VHD1SS119//1Y	X	Diode	AA
	D1007	RH-EX0263TAZZY	X	EX0263TA	AB
	D1012	RH-EX0611GEZZY	X	Zener	Diode 5.1V AB
	D1018	RH-EX0263TAZZY	X	EX0263TA	AB
	D1019	RH-EX0263TAZZY	X	EX0263TA	AB
Δ	VA701	RH-VX0073CEZZ	X	Varistor	AB
PACKAGED CIRCUITS					
	PR702	RMPTP0001PEZZ	X	Packaged Circuit	AE
	X1001	RCRSB0300CEZZ	X	Crystal	AC

Ref. No. Part No. ★ Description Code

**PWB-A: DUNTKA541WEC6
MAIN UNIT**

FILTERS AND COILS

CF253	RFILC0446CEZZ	X	Filter,	FiLC0446CE	AB
L202	VP-DF270K0000Y	X	Peaking,	27mH	AB
L203	VP-DF270K0000Y	X	Peaking,	27mH	AB
L204	VP-XF1R2K0000Y	X	Peaking	1.2mH	AB
L253	VP-XF120K0000Y	X	Peaking	12μH	AB
△ L701	RCILF0078PEZZ	X	Coil	Line Filter	AC
△ L751	RCILP0225CEZZ	X	Coil,		AB
L802	VP-DF100K0000Y	X	Peaking,	10mH	AB
L803	VP-DF100K0000Y	X	Peaking,	10mH	AB
L1030	VP-DF100K0000Y	X	Peaking,	10mH	AB
L1050	VP-DF100K0000Y	X	Peaking,	10mH	AB
L1051	VP-DF100K0000Y	X	Peaking,	10mH	AB
SF201	RFILC0405CEZZ	X	Filter	(4.5MHZ)	AD

TRANSFORMERS

△ T601	RTRNZ0144PEZZ	X	Transformer		AB
△ T602	RTRNF0229PEZZ	X	H-Volt Transformer		AP
△ T701	RTRNW0015PEZZ	X	Transformer		AE

CAPACITORS

[EL... Electrolytic, M-Poly... Metalized Polypro Film]

C201	VCEA0A1CW476M+	X	47	16V	EL.	AB
C202	VCEA0A1AW108M+	X	1000	10V	EL.	AB
C205	VCKYCY1HF103ZY	X	0.01	50V	Ceramic	AA
C206	VCEA0A1HW105M+	X	1	50V	EL.	AB
C207	VCKYCY1HB103KY	X	0.01	50V	Ceramic	AA
C208	VCKYCY1HB103KY	X	0.01	50V	Ceramic	AA
C209	VCKYCY1HB103KY	X	0.01	50V	Ceramic	AA
C210	VCKYCY1HF103ZY	X	0.01	50V	Ceramic	AA
C211	VCKYCY1HF103ZY	X	0.01	50V	Ceramic	AA
C231	VCKYCY1HF223ZY	X	0.022	50V	Ceramic	AA
△ C232	VCKYCY1HB821KY	X	820p	50V	Ceramic	AA
△ C233	VCKYCY1HB472KY	X	100	35V	EL.	AA
C234	VCKYCY1EF104ZY	X	0.1	25V	Ceramic	AA
C251	VCKYCY1HF223ZY	X	0.022	50V	Ceramic	AA
C252	VCEA0A1CW107M+	X	100	16V	EL.	AB
C301	VCEA0A1CW477M+	X	470	16V	EL.	AB
C304	VCEA0A1CW106M+	X	10	16V	EL.	AB
C307	VCEA0A1HW105M+	X	1	50V	EL.	AB
C310	VCEA0A1HW225M+	X	2.2	50V	EL.	AB
C311	VCEA0A1HW105M+	X	1	50V	EL.	AB
C312	VCEA0A1HW225M+	X	2.2	50V	EL.	AB
C313	VCKYCY1HB472KY	X	100	35V	EL.	AA
C332	VCQYTA1HM103J+	X	0.01	50V	Mylar	AB
C333	VCEA0A1CW108M+	X	1000	16V	EL.	AB
C356	VCKYCY1HB472KY	X	100	35V	EL.	AA
C359	VCEA0A1CW106M+	X	10	16V	EL.	AB
C360	VCEA0A1HW225M+	X	2.2	50V	EL.	AB
C409	VCKYCY1EF104ZY	X	0.1	25V	Ceramic	AA
C410	VCKYCY1EF104ZY	X	0.1	25V	Ceramic	AA
C411	VCKYCY1HB102KY	X	1000p	50V	Ceramic	AA
C501	VCKYPA1HB102K+	X	1000p	50V	Ceramic	AA
C504	VCKYCY1HB103KY	X	0.01	50V	Ceramic	AA
C505	VCEA0A1HW107M+	X	100	50V	EL.	AB
C507	VCKYCY1HB103KY	X	0.01	50V	Ceramic	AA
C508	VCFYSA1JB224J+	X	0.22	63V	Mylar	AB
C509	VCEA0A1CW477M+	X	470	16V	EL.	AB
C510	VCKYPA2HB102K+	X	1000p	500V	Ceramic	AB
C514	VCFYSA1JB473J+	X	0.047	63V	Mylar	AB
C531	VCKYCY1HB102KY	X	1000p	50V	Ceramic	AA
C532	VCKYCY1HB102KY	X	1000p	50V	Ceramic	AA
C533	VCQYTA1HM104J+	X	0.1	50V	Mylar	AB
C601	VCQYTA1HM563J+	X	0.056	50V	Mylar	AB
C602	VCEA0A1HW475M+	X	4.7	50V	EL.	AB

Ref. No. Part No. ★ Description Code

C603	VCEA0A1HW105M+	X	1	50V	EL.	AB
C604	VCEA0A2EW106M+	X	10	250V	EL.	AB
C605	VCKYPA2HB102K+	X	1000p	500V	Ceramic	AB
C606	VCFPVC2DB474J	X	0.47	200V	M-Poly.	AB
C607	VCFPVC3ZA772H	X	7700p	1.5kV	M-Poly.	AB
C608	VCKYPA2HB102K+	X	1000p	500V	Ceramic	AB
C610	VCEA0A1CW108M+	X	1000	16V	EL.	AB
C611	VCEA0A1EW476M+	X	47	25V	EL.	AB
C612	VCEA0A1CW477M+	X	470	16V	EL.	AB
C620	VCKYPA2HB102K+	X	1000p	500V	Ceramic	AB
C640	VCFYSB2EB823J	X	0.082	250V	M.Poly..	AB
C651	VCQYTA1HM222J+	X	2200p	50V	Mylar	AB
C652	VCQYTA1HM472J+	X	4700p	50V	Mylar	AB
C653	VCEA0A1HW105M+	X	1	50V	EL.	AB
C654	VCKYCY1HF223ZY	X	0.022	50V	Ceramic	AA
C655	VCEA0A1HW106M+	X	10	50V	EL.	AB
C656	VCEA0A1HW224M+	X	0.22	50V	EL.	AB
C657	VCKYCY1EF104ZY	X	0.1	25V	Ceramic	AA
C658	VCKYCY1EF104ZY	X	0.1	25V	Ceramic	AA
△ C701	RC-FZ036SCEZZ	X	0.1mF	AC125V	Plastic	AB
C702	RC-KZ0029CEZZ+	X	0.01	AC250V	Ceramic	AB
C703	RC-KZ0029CEZZ+	X	0.01	AC250V	Ceramic	AB
C704	RC-KZ0029CEZZ+	X	0.01	AC250V	Ceramic	AB
C705	RC-EZ0804CEZZ	X	220	400V	EL.	AH
C709	RC-KZ0039CEZZ	X	680	2kV	Ceramic	AB
C710	VCEA0A1HW476M+	X	47	50V	EL.	AB
C711	VCKYPA1HB102K+	X	1000p	50V	Ceramic	AA
C712	VCKYPA1HB471K+	X	470p	50V	Ceramic	AA
C713	VCKYPH3DB561K	X	560p	2kV	Ceramic	AB
△ C751	RC-KZ0092GEZZA	X	3300p	AC250V	Ceramic	AB
△ C752	VCKYPH3DB561K	X	560p	2kV	Ceramic	AB
△ C753	RC-EZ0724CEZZ	X	100	160V	EL.	AC
△ C754	RC-EZ0724CEZZ	X	100	160V	EL.	AC
△ C755	VCEA0A1CW108M+	X	1000	16V	EL.	AB
△ C756	VCQYTA1HM103J+	X	0.01	50V	Mylar	AB
C759	VCEA0A0JW477M+	X	470	6.3V	EL.	AB
C760	VCEA0A0JW228M+	X	2200	6.3V	EL.	AB
C801	VCEA0A1HW105M+	X	1	50V	EL.	AB
C802	VCEA0A1CW337M+	X	330	16V	EL.	AB
C803	VCEA0A1CW107M+	X	100	16V	EL.	AB
C804	VCKYCY1HB222KY	X	2200p	50V	Ceramic	AA
C805	VCKYD41HB102KY	X	1000p	50V	Ceramic	AB
C806	VCKYD41HB102KY	X	1000p	50V	Ceramic	AB
C807	VCKYD41HB102KY	X	1000p	50V	Ceramic	AB
C808	VCEA0A1CW107M+	X	100	16V	EL.	AB
C809	VCKYCY1CF474ZY	X	0.47	16V	Ceramic	AB
C810	VCKYCY1CF474ZY	X	0.47	16V	Ceramic	AB
C811	VCEA0A1CW107M+	X	100	16V	EL.	AB
C812	VCFYFA1HA224J+	X	0.22	50V	Mylar	AB
C813	VCFYFA1HA224J+	X	0.22	50V	Mylar	AB
C814	VCKYCY1HB471KY	X	470p	50V	Ceramic	AA
C816	VCKYCY1HB471KY	X	470p	50V	Ceramic	AA
C1001	VCEA0A0JW107M+	X	100	6.3V	EL.	AB
C1002	VCEA0A0JW107M+	X	100	6.3V	EL.	AB
C1003	VCEA0A1CW106M+	X	10	16V	EL.	AB
C1004	VCKYCY1CF474ZY	X	0.47	16V	Ceramic	AB
C1005	VCKYCY1CF474ZY	X	0.47	16V	Ceramic	AB
C1006	VCEA0A1CW106M+	X	10	16V	EL.	AB
C1008	VCCCY1HH330JY	X	33p	50V	Ceramic	AA
C1009	VCCCY1HH330JY	X	33p	50V	Ceramic	AA
C1010	VCEA0A0JW107M+	X	100	6.3V	EL.	AB
C1011	VCKYCY1CF474ZY	X	0.47	16V	Ceramic	AB
C1012	VCKYCY1CF474ZY	X	0.47	16V	Ceramic	AB
C1013	VCEA0A0JW107M+	X	100	6.3V	EL.	AB
C1016	VCQYTA1HM104J+	X	0.1	50V	Mylar	AB
C1018	VCKYCY1HB221KY	X	220p	50V	Ceramic	AA
C1024	VCQYTA1HM104J+	X	0.1	50V	Mylar	AB
C1026	VCEA0A0JW107M+	X	100	6.3V	EL.	AB

Ref. No.	Part No.	★	Description	Code	Ref. No.	Part No.	★	Description	Code	
PWB-A: DUNTKA541WEC6					R310	VRS-CY1JF473JY	X	47k	1/16W M-	
MAIN UNIT					R311	VRS-CY1JF473JY	X	47k	1/16W M-	
RESISTORS					R313	VRS-CY1JF102JY	X	1k	1/16W M-	
[M-Ox. ...Metal Oxide, M-Film ...Metal Film]					R314	VRS-CY1JF103JY	X	10k	1/16W M-	
RJ2	VRS-CY1JF000JY	X	00	1/16W M-Ox.	AA	R315	VRS-CY1JF822JY	X	8.2k	1/16W M-
RJ4	VRS-CY1JF000JY	X	00	1/16W M-Ox.	AA	R322	VRS-CY1JF272JY	X	2.7k	1/16W M-
RJ8	VRS-CY1JF000JY	X	00	1/16W M-Ox.	AA	R323	VRD-RA2BE274JY	X	270k	1/8W Ca
RJ9	VRS-CY1JF000JY	X	00	1/16W M-Ox.	AA	R333	VRS-CY1JF101JY	X	100	1/16W M-
RJ10	VRS-CY1JF000JY	X	00	1/16W M-Ox.	AA	R334	VRS-CY1JF332JY	X	3.3k	1/16W M-
RJ13	VRS-CY1JF000JY	X	00	1/16W M-Ox.	AA	R335	VRS-CY1JF564JY	X	560k	1/16W M-
RJ14	VRS-CY1JF000JY	X	00	1/16W M-Ox.	AA	R364	VRS-CY1JF000JY	X	00	1/16W M-
RJ15	VRS-CY1JF000JY	X	00	1/16W M-Ox.	AA	R431	VRS-CY1JF101JY	X	100	1/16W M-
RJ16	VRS-CY1JF000JY	X	00	1/16W M-Ox.	AA	R432	VRS-CY1JF750JY	X	75	1/16W M-
RJ17	VRS-CY1JF000JY	X	00	1/16W M-Ox.	AA	R501	VRD-RA2BE222JY	X	2.2k	1/8W Ca
RJ19	VRS-CY1JF000JY	X	00	1/16W M-Ox.	AA	R502	VRD-RM2HD102JY	X	1.0k	1/2W Ca
RJ21	VRS-CY1JF000JY	X	00	1/16W M-Ox.	AA	R503	VRN-RL3DB2R2J+	X	2.2	2W M-
RJ24	VRS-CY1JF000JY	X	00	1/16W M-Ox.	AA	R504	VRS-CY1JF181JY	X	180	1/16W M-
RJ26	VRS-CY1JF000JY	X	00	1/16W M-Ox.	AA	R505	VRS-CY1JF102JY	X	1k	1/16W M-
RJ28	VRS-CY1JF000JY	X	00	1/16W M-Ox.	AA	R506	VRS-RG3AB391J+	X	390	1W M-
RJ32	VRS-CY1JF000JY	X	00	1/16W M-Ox.	AA	R507	VRN-RL3AB1R0J+	X	1.0	1W M-
RJ33	VRS-CY1JF000JY	X	00	1/16W M-Ox.	AA	R510	VRD-RA2BE333JY	X	33k	1/8W Ca
RJ35	VRS-CY1JF000JY	X	00	1/16W M-Ox.	AA	R511	VRS-CY1JF181JY	X	180	1/16W M-
RJ37	VRS-CY1JF000JY	X	00	1/16W M-Ox.	AA	R512	VRD-RM2HD100JY	X	10	1/2W Ca
RJ38	VRS-CY1JF000JY	X	00	1/16W M-Ox.	AA	R531	VRS-CY1JF101JY	X	100	1/16W M-
RJ41	VRS-CY1JF000JY	X	00	1/16W M-Ox.	AA	R532	VRS-CY1JF101JY	X	100	1/16W M-
RJ42	VRS-CY1JF000JY	X	00	1/16W M-Ox.	AA	R533	VRD-RA2BE393JY	X	39k	1/8W Ca
RJ43	VRS-CY1JF000JY	X	00	1/16W M-Ox.	AA	R601	VRS-RG2HC102J+	X	1k	1/2W M-
RJ46	VRS-CY1JF000JY	X	00	1/16W M-Ox.	AA	R602	VRD-RA2BE393JY	X	39k	1/8W Ca
RJ49	VRS-CY1JF000JY	X	00	1/16W M-Ox.	AA	R603	VRD-RA2BE223JY	X	22k	1/8W Ca
RJ50	VRS-CY1JF000JY	X	00	1/16W M-Ox.	AA	R604	VRD-RA2BE393JY	X	39k	1/8W Ca
RJ51	VRS-CY1JF000JY	X	00	1/16W M-Ox.	AA	R605	VRD-RM2HD823JY	X	82k	1/2W Ca
RJ52	VRS-CY1JF000JY	X	00	1/16W M-Ox.	AA	△ R606	VRN-RL3AB2R2J+	X	2.2	1W M-
RJ53	VRS-CY1JF000JY	X	00	1/16W M-Ox.	AA	△ R607	VRD-RM2HD270JY	X	27	1/2W Ca
RJ55	VRS-CY1JF000JY	X	00	1/16W M-Ox.	AA	△ R609	VRD-RA2BE154JY	X	150k	1/8W Ca
RJ70	VRS-CY1JF000JY	X	00	1/16W M-Ox.	AA	△ R610	VRD-RA2BE102GY	X	1.0k	1/8W Ca
RJ71	VRS-CY1JF000JY	X	00	1/16W M-Ox.	AA	R611	VRS-CY1JF102JY	X	1k	1/16W M-
RJ73	VRS-CY1JF000JY	X	00	1/16W M-Ox.	AA	R612	VRS-CY1JF123JY	X	12k	1/16W M-
RJ75	VRS-CY1JF000JY	X	00	1/16W M-Ox.	AA	R613	VRS-CY1JF103JY	X	10k	1/16W M-
RJ76	VRS-CY1JF000JY	X	00	1/16W M-Ox.	AA	△ R614	VRS-RG2HC100J+	X	10	1/2W M-
RJ77	VRS-CY1JF000JY	X	00	1/16W M-Ox.	AA	R615	VRS-RG3DB682J+	X	6.8k	2W M-
R201	VRS-CY1JF101JY	X	100	1/16W M-Ox.	AA	R616	VRN-RL3ABR47J+	X	0.47	1W M-
R202	VRS-CY1JF101JY	X	100	1/16W M-Ox.	AA	R618	VRS-RG3DB391J+	X	390	2W M-
R205	VRS-CY1JF680JY	X	68	1/16W M-Ox.	AA	R619	VRS-RG3LB562J+	X	5.6k	3W M-
R206	VRS-CY1JF122JY	X	1.2k	1/16W M-Ox.	AA	R620	VRS-RG3AB472J+	X	4.7k	1W M-
R207	VRS-CY1JF221JY	X	220	1/16W M-Ox.	AA	R622	VRD-RA2BE102JY	X	1k	1/8W Ca
R208	VRS-CY1JF122JY	X	1.2k	1/16W M-Ox.	AA	R625	VRN-VV3DB4R7J	X	4.7	2W M-
R209	VRS-CY1JF392JY	X	3.9k	1/16W M-Ox.	AA	R626	VRD-RM2HD470JY	X	47	1/2W Ca
R216	VRS-RG3LB223J+	X	22k	3W M-Ox.	AB	R641	VRN-RL2HCR47J+	X	0.47	1/2W M-
R219	VRD-RA2BE392JY	X	3.9k	1/8W Carbon	AA	R651	VRS-CY1JF223JY	X	22k	1/16W M-
R220	VRS-CY1JF221JY	X	220	1/16W M-Ox.	AA	R652	VRS-CY1JF102JY	X	1k	1/16W M-
R230	VRS-CY1JF473JY	X	47k	1/16W M-Ox.	AA	R653	VRS-CY1JF822JY	X	8.2k	1/16W M-
R231	VRD-RA2BE681JY	X	1.5k	1/8W Carbon	AA	R654	VRS-CY1JF273JY	X	27k	1/16W M-
R232	VRS-CY1JF272JY	X	2.7k	1/16W M-Ox.	AA	R655	VRS-CY1JF391JY	X	390	1/16W M-
R233	VRS-CY1JF101JY	X	100	1/16W M-Ox.	AA	R656	VRS-CY1JF100JY	X	10	1/16W M-
R234	VRS-CY1JF391JY	X	390	1/16W M-Ox.	AA	R658	VRD-RA2BE101JY	X	100	1/8W Ca
R257	VRS-CY1JF181JY	X	180	1/16W M-Ox.	AA	R663	VRD-RA2BE101JY	X	100	1/8W Ca
R258	VRS-CY1JF181JY	X	180	1/16W M-Ox.	AA	R701	VRW-KQ3NC3R9K	X	3.9	7W Ce
R259	VRS-CY1JF471JY	X	470	1/16W M-Ox.	AA	R704	VRN-SV2HC1R0J	X	1.0	1/2W M-
R260	VRS-CY1JF392JY	X	3.9k	1/16W M-Ox.	AA	R707	VRS-VV3DB104J	X	100k	2W M-
R261	VRS-CY1JF223JY	X	22k	1/16W M-Ox.	AA	R708	VRD-RA2BE681JY	X	1.5k	1/8W Ca
R262	VRS-CY1JF560JY	X	56	1/16W M-Ox.	AA	R709	VRN-RL3DBR47J+	X	0.47	2W M-
R263	VRS-CY1JF560JY	X	56	1/16W M-Ox.	AA	R710	VRN-RL3DBR39J+	X	0.39	2W M-
R301	VRS-CY1JF101JY	X	100	1/16W M-Ox.	AA	R711	VRD-RA2BE682JY	X	6.8k	1/8W Ca
R304	VRS-CY1JF683JY	X	68k	1/16W M-Ox.	AA	R712	VRD-RA2BE152JY	X	1.5k	1/8W Ca
R305	VRS-CY1JF274JY	X	270k	1/16W M-Ox.	AA	R716	VRD-RA2BE562JY	X	5.6k	1/8W Carbon
R307	VRS-CY1JF000JY	X	00	1/16W M-Ox.	AA	△ R751	RR-DZ0049CEZZY	X	3.9M	1/2W Solid
						△ R752	RR-DZ0049CEZZY	X	3.9M	1/2W Solid
						△ R753	VRD-RM2HD124JY	X	120k	1/2W Carbon

Ref. No. Part No. ★ Description Code

**PWB-A: DUNTKA541WEC6
MAIN UNIT****RESISTORS***[M-Ox... Metal Oxide, M-Film ... Metal Film]*

R754	VRD-RM2HD150JY	X	15	1/2W	Carbon	AA
R755	VRD-RA2BE221JY	X	220	1/8W	Carbon	AA
R756	VRD-RM2HD270JY	X	27	1/2W	Carbon	AA
R757	VRS-CY1JF151JY	X	150	1/16W	M-Ox.	AA
R801	VRS-CY1JF221JY	X	220	1/16W	M-Ox.	AA
R802	VRS-CY1JF221JY	X	220	1/16W	M-Ox.	AA
R803	VRS-CY1JF221JY	X	220	1/16W	M-Ox.	AA
R804	VRS-CY1JF221JY	X	220	1/16W	M-Ox.	AA
R805	VRS-CY1JF822JY	X	8.2k	1/16W	M-Ox.	AA
R806	VRS-CY1JF123JY	X	12k	1/16W	M-Ox.	AA
R807	VRS-CY1JF103JY	X	10k	1/16W	M-Ox.	AA
R808	VRS-CY1JF221JY	X	220	1/16W	M-Ox.	AA
R809	VRD-RA2BE224JY	X	220k	1/8W	M-Ox.	AA
R812	VRS-CY1JF101JY	X	100	1/16W	M-Ox.	AA
R813	VRS-CY1JF221JY	X	220	1/16W	M-Ox.	AA
R1002	VRS-CY1JF822JY	X	8.2k	1/16W	M-Ox.	AA
R1003	VRS-CY1JF562JY	X	5.6k	1/16W	M-Ox.	AA
R1006	VRS-CY1JF562JY	X	5.6k	1/16W	M-Ox.	AA
R1007	VRS-CY1JF562JY	X	5.6k	1/16W	M-Ox.	AA
R1008	VRS-CY1JF822JY	X	8.2k	1/16W	M-Ox.	AA
R1009	VRS-CY1JF562JY	X	5.6k	1/16W	M-Ox.	AA
R1011	VRS-CY1JF332JY	X	3.3k	1/16W	M-Ox.	AA
R1012	VRD-RA2BE391JY	X	390	1/8W	Carbon	AA
R1013	VRD-RA2BE101JY	X	100	1/8W	Carbon	AA
R1014	VRS-CY1JF101JY	X	100	1/16W	M-Ox.	AA
R1015	VRS-CY1JF332JY	X	3.3k	1/16W	M-Ox.	AA
R1016	VRS-CY1JF101JY	X	100	1/16W	M-Ox.	AA
R1017	VRS-CY1JF332JY	X	3.3k	1/16W	M-Ox.	AA
R1019	VRS-CY1JF000JY	X	00	1/16W	M-Ox.	AA
R1020	VRS-CY1JF101JY	X	100	1/16W	M-Ox.	AA
R1021	VRS-CY1JF183JY	X	18k	1/16W	M-Ox.	AA
R1022	VRS-CY1JF101JY	X	100	1/16W	M-Ox.	AA
R1023	VRS-CY1JF221JY	X	220	1/16W	M-Ox.	AA
R1024	VRS-CY1JF183JY	X	18k	1/16W	M-Ox.	AA
R1025	VRS-CY1JF101JY	X	100	1/16W	M-Ox.	AA
R1026	VRS-CY1JF224JY	X	220k	1/16W	M-Ox.	AA
R1028	VRS-CY1JF101JY	X	100	1/16W	M-Ox.	AA
R1032	VRS-CY1JF332JY	X	3.3k	1/16W	M-Ox.	AA
R1034	VRS-CY1JF101JY	X	100	1/16W	M-Ox.	AA
R1035	VRS-CY1JF332JY	X	3.3k	1/16W	M-Ox.	AA
R1036	VRS-CY1JF332JY	X	3.3k	1/16W	M-Ox.	AA
R1037	VRS-CY1JF101JY	X	100	1/16W	M-Ox.	AA
R1038	VRS-CY1JF101JY	X	100	1/16W	M-Ox.	AA
R1039	VRS-CY1JF223JY	X	22k	1/16W	M-Ox.	AA
R1040	VRS-CY1JF101JY	X	100	1/16W	M-Ox.	AA
R1041	VRS-CY1JF101JY	X	100	1/16W	M-Ox.	AA
R1042	VRD-RA2BE471JY	X	470	1/8W	Carbon	AA
R1046	VRS-CY1JF101JY	X	100	1/16W	M-Ox.	AA
R1047	VRS-CY1JF332JY	X	3.3k	1/16W	M-Ox.	AA
R1050	VRS-CY1JF392JY	X	3.9k	1/16W	M-Ox.	AA
R1051	VRS-CY1JF683JY	X	68k	1/16W	M-Ox.	AA
R1066	VRS-CY1JF273JY	X	27k	1/16W	M-Ox.	AA
R1072	VRS-CY1JF101JY	X	100	1/16W	M-Ox.	AA
R1073	VRS-CY1JF101JY	X	100	1/16W	M-Ox.	AA
JA721	VRD-RA2BE102JY	X	1k	1/8W	Carbon	AA

SWITCHES

S1001	QSW-KA003WJZZ+	X	Switch,			AB
S1002	QSW-KA003WJZZ+	X	Switch,			AB
S1003	QSW-KA003WJZZ+	X	Switch,			AB
S1004	QSW-KA003WJZZ+	X	Switch,			AB
S1005	QSW-KA003WJZZ+	X	Switch,			AB
S1006	QSW-K0114CEZZ	X	Switch,			AC

Ref. No. Part No. ★ Description Code

MISCELLANEOUS PARTS

△ F701	QFS-C3229CEZZ	X	Fuse,	T3.14AL		AB
FB601	RBLN-0091GEZZY	X	Ferrite Bead			AB
FH701	QFSDH1013CEZZ+	X	FUSE CLIP			AB
FH702	QFSDH1014CEZZ+	X	FUSE CLIP			AB
J402	QJAKE0210CE04	X	Jack, Video (AV-In2)			AB
J403	QJAKE0210CE09	X	Jack, Audio (L)(AV-In2)			AB
J409	QJAKF0074CEZZ	X	Jack, Rear AV-In			AC
P302	QPLGN0461CEZZ	X	PLUG (4 PINS)			AB
P601	QPLGN0660CEZZ	X	PLUG (6 PINS)			AB
P602	LHLDW1104PEZZ	X	Holder			AB
P603	QPLGN0361CEZZA	X	Plug, 3pin	(TP651-3)		AB
P701	QPLGN0260CEZZ	X	Plug, 2pin	(M1-2)		AB
P702	QPLGN0269GEZZ	X	Plug, 2pin	(P1-2)		AB
P1001	LHLDW1105PEZZ	X	Holder			AB
P1002	QPLGN0561CEZZ	X	PLUG (5 PINS)			AB
RMC1001	RRMCU0222CEZZ	X	R/C RECEIVER			AD
RDA301	PRDAR0119GJFW	X	Heat Sink,	for IC301		AB
RDA501	PRDAR0118GJFW	X	Heat Sink,	for IC501		AB
RDA602	PRDAR0224PEFW	X	Heat Sink	for Q602		AB
RDA701	PRDAR0298PEFW	X	Heat Sink,	for IC701		AC
TP201	QLUGP0102PEZZ	X	Lug			AA
	LHLDP1066PE00	X	Holder			AB
	QCNW-2619PEZZ	X	Connecting Cord			AB
	QCNW-2620PEZZ	X	Connecting Cord			AB

**PWB-B: DUNTKA542WEB3
CRT UNIT****TRANSISTORS**

Q870	RH-TX0110BMZZ+	X	TX0110BM			AB
Q871	RH-TX0110BMZZ+	X	TX0110BM			AB
Q872	RH-TX0110BMZZ+	X	TX0110BM			AB
Q883	RH-TX0124BMZZ+	X	TX0124BM			AB
Q885	RH-TX0124BMZZ+	X	TX0124BM			AB
Q887	RH-TX0124BMZZ+	X	TX0124BM			AB

DIODES

D881	VHD1SS244//1Y	X	Diode			AB
D882	VHD1SS244//1Y	X	Diode			AB
D883	VHD1SS244//1Y	X	Diode			AB
D884	VHD1SS119//1Y	X	Diode			AA
D885	VHD1SS119//1Y	X	Diode			AA
D886	VHD1SS82///1AY	X	Diode			AB
D887	VHD1SS82///1AY	X	Diode			AB
D888	VHD1SS82///1AY	X	Diode			AB

CAPACITORS*[EL... Electrolytic, M-Poly... Metalized Polypro Film]*

C871	VCCSCY1HL471JY	X	470p	50V	Ceramic	AB
C872	VCCSCY1HL391JY	X	390p	50V	Ceramic	AB
C873	VCCSCY1HL471JY	X	470p	50V	Ceramic	AB
C875	VCKYPA2HB102K+	X	1000p	500V	Ceramic	AB
C876	RC-KZ0150CEZZ	X	1000p	3kV	Ceramic	AB
C878	VCEA0A2EW106M+	X	10	250V	EL.	AB
C880	VCCSCY1HL471JY	X	470p	50V	Ceramic	AB
C881	VCKYPA1HB471K+	X	470p	50V	Ceramic	AA
C882	VCKYPA1HB471K+	X	470p	50V	Ceramic	AA
C886	VCKYPA2HB102K+	X	1000p	500V	Ceramic	AB

RESISTORS*[M-Ox... Metal Oxide, M-Film ... Metal Film]*

R879	VRS-CY1JF471JY	X	470	1/16W	M-Ox.	AA
R880	VRS-CY1JF471JY	X	470	1/16W	M-Ox.	AA
R881	VRS-CY1JF471JY	X	470	1/16W	M-Ox.	AA
R882	VRS-VV3DB153J	X	15k	2W	M-Ox.	AB
R883	VRD-RM2HD272JY	X	2.7k	1/2W	Carbon	AA
R884	VRS-VV3DB153J	X	15k	2W	M-Ox.	AB
R885	VRD-RM2HD272JY	X	2.7k	1/2W	Carbon	AA
R886	VRS-VV3DB153J	X	15k	2W	M-Ox.	AB
R887	VRD-RM2HD272JY	X	2.7k	1/2W	Carbon	AA

Ref. No. Part No. ★ Description Code

**PWB-B: DUNTKA542WEB3
CRT UNIT**

RESISTORS

[M-Ox... Metal Oxide, M-Film ... Metal Film]

R888	VRS-CY1JF471JY	X	470	1/16W	M-Ox.	AA
R892	VRS-CY1JF102JY	X	1k	1/16W	M-Ox.	AA
R893	VRS-CY1JF102JY	X	1k	1/16W	M-Ox.	AA
R894	VRS-CY1JF102JY	X	1k	1/16W	M-Ox.	AA
R898	VRS-CY1JF471JY	X	470	1/16W	M-Ox.	AA
R899	VRS-CY1JF471JY	X	470	1/16W	M-Ox.	AA

P882	LHLDW1105PEZZ	X	Holder			AB
P884	LHLDW1104PEZZ	X	Holder			AB

SC881	QSOCV0840CEZZ	X	SOCKET (CRT)			AC
-------	---------------	---	--------------	--	--	----

MISCELLANEOUS PARTS

△ ACC701	QACCZA020WJPZ	X	AC Cord			AE
SP301	VSP9050PB40YA	X	SPEAKER			AE
SP302	VSP9050PB40YA	X	SPEAKER			AE
	LHLDK0012PEZZ	X	AC CORD HOLDER			AB
	LHLDW1009PEZZ	X	Purse Lock (0.115cm)			AB
	LHLDW1033PEZZ	X	WIRE TIE (10.4 CM)			AA
	LHLDW1060CEZZ	X	Purse Lock (0.83 cm)			AB
	LHLDW1070PEKZ	X	AC Cord Holder Clamp u			AB
	LHLDZ0063PEZZ	X	HOLDER (Insulator Ring)			AB
	LX-TZ3004CEFD	X	SCREW			AA
	QCNW-2562PEZZ	X	WIRE (SPEAKER)			AC
	TLABM0005GJZZ	X	Model Label			AB
	TLABN0101GJZZ	X	Remark label(chassis ID)			AB
	TLABZ0204GJZZ	X	Case Label			AB

SUPPLIED ACESORRIES

TINS-7668GJZZ	X	Operation Manual	AD
RRMCG1339CESB	X	Infrared R-C Unit	AH
TCAUH0102GJZZ	X	Caution Card	AA
TCAUS3000GJZZ	X	CAUTION LABEL	AA

Ref. No. Part No. ★ Description Code

**PACKING PARTS
(NOT REPLACEMENT ITEM)**

SPAKC0208GJZZ	X	Packing Case	AQ
SPAKP0102GJZZ	X	LAMIFOAM	AC
SPAKX0124GJZZ	X	Packing Foam	AH
SSAKA0101GJZZ	X	PLASTIC BAG	AB

CABINET PARTS

1	CCABAA009WEH3	X	Front Cabinet Ass'y	AY
1-1		—	Front Cabinet	—
1-2	HBDGB1001GJSB	X	Badge	AB
1-3	JBTN-0113GJSC	X	Button	—
1-4	GCOVA0110GJSA	X	R/C Cover	AH
1-5	JBTN-0114GJSC	X	Button	—
1-6	MSPRC0005PEFW	X	SPRING	AA
2	GCABB0128GJKA	X	Rear Cabinet	AV

CABINET PARTS LOCATION

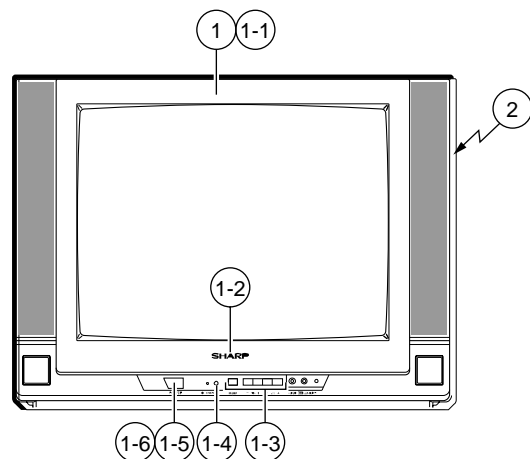

PACKING OF THE SET

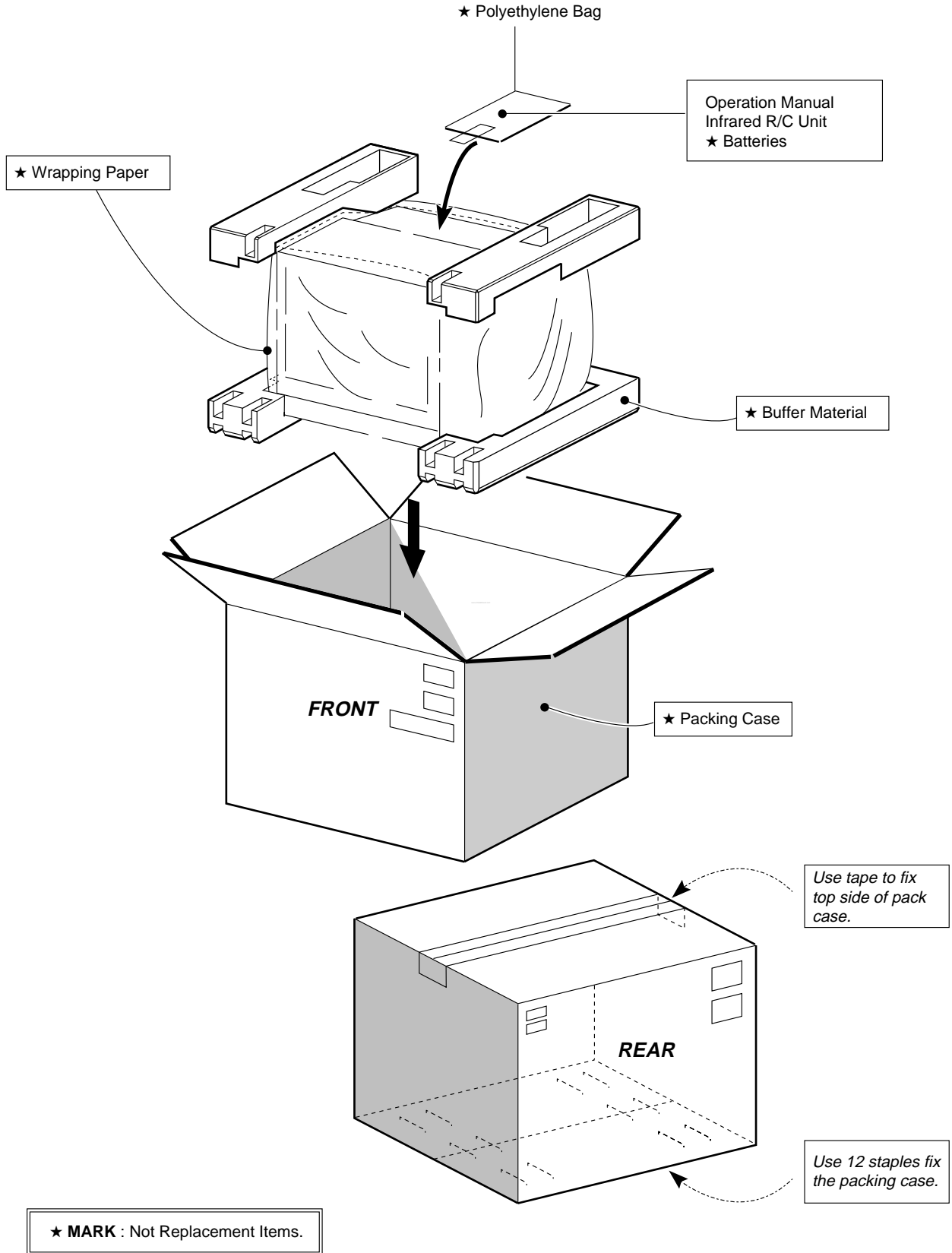

SHARP

COPYRIGHT © 2002 BY SHARP CORPORATION

ALL RIGHTS RESERVED.

No part of this publication may be reproduced, stored in a retrieval system, or transmitted in any form or by any means, electronic, mechanical, photocopying, recording, or otherwise, without prior written permission of the publisher.